

DECEMBER, 1923

Radio Topics



20 Cents

Muriel Holmquist - Oak Park

MANHATTAN

ELECTRICAL SUPPLY CO., INC.

MAKERS OF THE FAMOUS



MANHATTAN
LOUD SPEAKER

OLDEST AND LARGEST
DISTRIBUTORS OF

Radio Corporation
of America

WORLD WIDE WIRELESS



*The Manhattan Loud Speaker
with its "concert modulator"
gives real tone quality.*

KENNEDY
EQUIPMENT

114 SO. WELLS ST., CHICAGO

NEW YORK

ST. LOUIS

SAN FRANCISCO



Buy at the Radio Store where they display this sign—the distinguishing mark of Blairco Proven Products.



ATLAS HEAD PHONES

The only high-grade receiver set offered at a reasonable price. Sensitiveness and adaptability positively is unequalled. Price \$9.00.

Atlas Loud Speaker

Height over all, 21 in. Horn, 11 in. in diameter, of seamless vegetable fibre, dense and non-vibrating. Sound reflecting base and unit casing of dark red polished Bakelite. Priced complete with horn attachment and cord,

\$25.00.



The ATLAS Gives Tone Volume With Perfect Tone Control

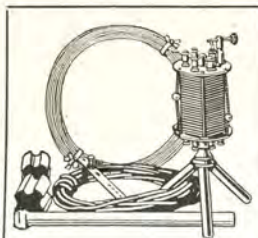

Blairco "4" Crystal Set

Takes 4 head phones—Enables 4 to listen as well as 1. All nicked steel 9 in. high. Price only \$7.50.

Complete with copper clad aerial, waterproof lead-in and ground wire, strain and wall tube insulators, lightning arrester ground wire clamp and set of \$9.00 Blairco Headphones, \$17.50.

Dealers: An unbeatable profit opportunity is offered you in the Blairco Proven Products. Write quick for our proposition.

Multiplied enjoyment with your radio follows the use of a loud speaker which, set in any convenient spot, throws out the tones so that a roomful of family and friends can hear.

But in selecting the loud speaker, bear in mind that loudness without clearness is mere noise—and get an ATLAS.

With the Atlas you get the true tone of the original—clear, pure, exquisitely sweet—and perfectly controlled. Tone distortion, distracting mechanical sounds, confusing echoes and blasts—all are noticeably absent.

All is due to the patented double composition diaphragm—found only in the Atlas. And to the use of finer materials which, with scientific assembling, also insures permanence.

A typical example of the extra quality afforded at no extra cost by all radio equipment sold under the Blairco trademark.

No matter what you want in Radio, buy at the "Blairco" Radio store and get dependable value. Every article sold under the Blairco trade name, whether our own make or others, is of proved superiority. Exacting tests have proved it the best of its kind, bar none!

If you have no Blairco dealer, write us now for Folder and Prices

Mitchell Blair Co.

'First With the Best'

1429 So. Michigan Ave., Chicago

CLASS OF SERVICE	SYMBOL
Telegram	
Day Letter	Blue
Night Message	Nite
Night Letter	N L

If none of these three symbols appears after the check (number of words) this is a telegram. Otherwise its character is indicated by the symbol appearing after the check.

WESTERN UNION TELEGRAM

NEWCOMB CARLTON, PRESIDENT GEORGE W. E. ATKINS, FIRST VICE-PRESIDENT

Form 1204

CLASS OF SERVICE	SYMBOL
Telegram	
Day Letter	Blue
Night Message	Nite
Night Letter	N L

If none of these three symbols appears after the check (number of words) this is a telegram. Otherwise its character is indicated by the symbol appearing after the check.

RECEIVED AT²¹NORTH WASHINGTON ST.
JAMAICA, N. Y.
IN CBU 50 NL

AVALON CALIF OCT 25-26 1923

DOUGLAS RIGNEY

A. H. GREBE & CO VANWYCK BLVD RICHMONDHILL LI. NY
COPIED MACMILLIAN SHIP TWO HOURS LAST NIGHT ON THIRTEEN TOOK
MANY MESSAGES AND PRESS REPORTS THEY ARE ELEVEN DEGREES FROM
POLE ALL WELL HEAVY SNOW TEMPERATURE BELOW ZERO SAW SUN
FOR LAST TIME YESTERDAY EASILY WORK HIM ON YOUR SPLENDID
RECEIVER AM FIRST AMERICAN PACIFIC COAST STATION TO HEAR HIM
MAJOR LAWRENCE MOTT

816A



*"The coming of a friend
from a far-off land—is
this not true joy?"*
—Confucius.

*Talking with a friend in
a far-off land is also
true delight when one
uses a Grebe "13."*

Doctor Thru



Copying the "Bowdoin" With the Grebe "13"

Major Lawrence Mott, 6XAD—6ZW, Avalon, Cal., needs no introduction to the amateur fraternity.

We congratulate Major Mott upon his success in copying the "Bowdoin" for two hours. That his should be the first U. S. Pacific Coast Station to hear the MacMillan ship for so long a period is fitting testimony of the Major's ability as an operator and of the excellence of his equipment.

We are pleased to learn that the Grebe "13" was the Receiver used by Major Mott.

Write us.

A. H. GREBE & CO., Inc.

77 Van Wyck Blvd.

Richmond Hill, N. Y.

Western Branch: 451 East 3rd Street, Los Angeles, Calif.



Licensed under Armstrong
U. S. Patent No. 1,113, 149



Radio Topics



An Illustrated Monthly Devoted to Radio

Volume III

December, 1923

Number 11

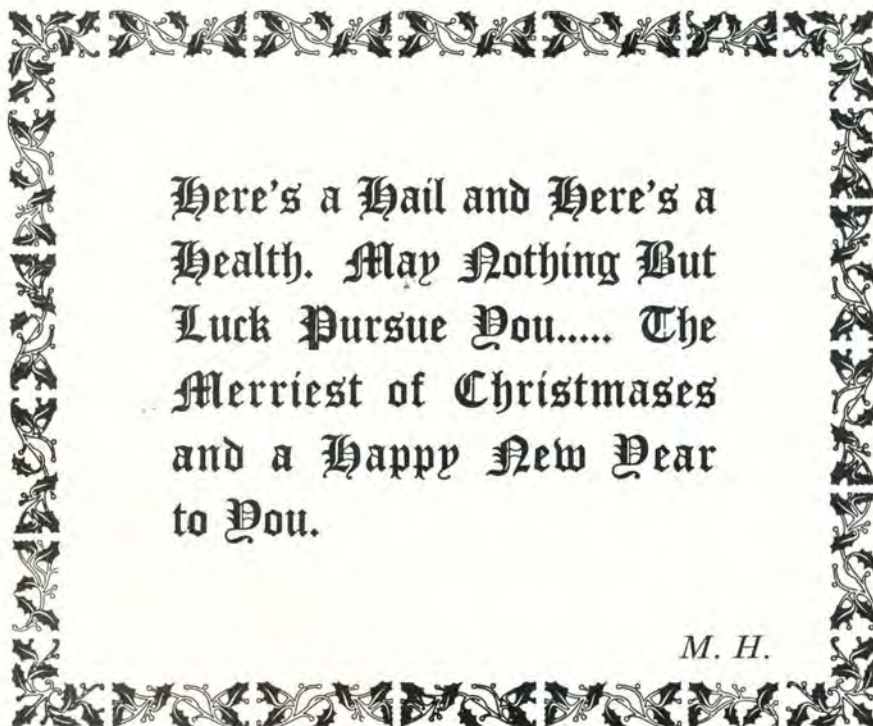

Here's a Hail and Here's a
Health. May Nothing But
Luck Pursue You..... The
Merriest of Christmases
and a Happy New Year
to You.

M. H.

CONTENTS

The Perasco Girl.....	Cover
Greatest Radio Show Ever Held.....	7
Why Newspapers Broadcast.....	9
The Future of Radio Broadcasting, by Martin Price.....	11
A Page of Interesting Pictures.....	13
Essentials of Good Reception, by Alphonso Paul.....	14
A Real DX Bringer-in, by Paul A. Perry.....	15
Reaching Across Oceans With Radio, by E. F. W. Alexanderson....	17
How to Build a Good Audio-Frequency Amplifier, by Edson Caldwell	19
Correspondence With Our Readers.....	21
How to Build a Real DX Set, by L. H. Hallgren.....	23
Does the Crystal Set Broadcast, by Paul Green.....	25

PUBLISHED MONTHLY BY RADIO TOPICS

Entered as second-class matter at the Postoffice at Oak Park, Ill., February 25, 1922,
under the Act of Congress of March 3, 1879.

Business and Editorial Office at 1112 North Blvd., Oak Park, Ill.

Chicago Phone: Austin 9300.

New York Office, 240 Broadway

Copyright 1923, by Radio Topics

RADIO TOPICS

The National Radio Monthly



FOUNDED 1921

PUBLISHED EVERY MONTH BY
RADIO TOPICS, PUBLISHERS

1112 North Blvd.

OAK PARK, ILLINOIS, U. S. A.

J. RAY MURRAY, EDITOR
NANKO C. BOS, Managing Editor
WILL M. HIGHT, Business Manager

PUBLISHING AND EDITORIAL OFFICES

Chicago Phone: Austin 9300. Oak Park Phone: Oak Park 3200

Twenty Cents the Copy From All Newsdealers. By Subscription:
To the United States and Possessions, Cuba and Mexico, \$2.00 the
Year. Remit by U. S. Money Order, Express Money Order, Check or
by Draft, payable in U. S. Funds.

To Canada—By Subscription, \$3.00 the Year. Single Copies 25
Cents—Canadian or U. S. Funds.

RADIO TOPICS is on sale the 10th of preceding month.
Text and advertising forms close the 22nd of second
month preceding issue.

Vol. III

December, 1923

No. 11

Greatest Show Ever Held

THE outstanding event in radio circles was the Second Annual Radio Show in Chicago, which was held November 20 to 25, inclusive. It was in point of attendance and enthusiasm the greatest radio show ever held, and lived up to the billing, "The World's Greatest."

It was a credit to U. J. Hermann, under whose management the show was given, and James F. Kerr, who directed it. It was also a credit to the manufacturers who made the exposition possible.

There was a noticeable lack of din and confusion during the entire week in the immense Coliseum, something unheard of at every other radio show. The only radio reception permitted was under the supervision of the radio authorities, and the loud speakers were not blating out discordant sounds from every angle.

The marked enthusiasm of amateurs in the contests staged at the show where crystal sets vied with fourteen-tube outfits, and in the Listeners' Vote drawings, showed how popular radio has become. Many notables attended the exhibit and mingled with the crowds that flocked from booth to

booth in search of new wrinkles and the latest devices.

Radio a Boon to Isolated

DR. LEE DeFOREST, inventor of the three electrode type of audion tube, who attended the Second Annual Chicago Radio Show and addressed the visitors to the show on November 22, paid a splendid tribute to the magazines and papers of the country for spreading the knowledge of radio to the multitudes.

Dr. DeForest said that radio broadcasting's educational possibilities were tremendous. It has made thousands of people study physics and the theories of electricity who otherwise might never have developed their minds to that point. Every radio fan, too, is a student of geography. He has a better knowledge of the United States, its principal cities, and a fair conception of distances. This was not true five years ago.

But the greatest thing to radio, according to Dr. DeForest, is the taking away of loneliness from the farms and outlying communities. He said it is making for contentment in American homes and is making home bodies of many people who used to be bored to death in their own homes.

The famous scientist said that radio is no longer a fad—the attendance at radio shows this year proved that—and he predicted it will continue to grow and expand until it stands as one of the largest industries of the world.

THE passing of Charles P. Steinmetz, chief consulting engineer of the General Electric Company, at his home in Schenectady, N. Y., was a severe blow to radio and the scientific world. He was with General Electric thirty years and had a world-wide reputation as a scientist, electrical engineer, author and teacher, and at the time of his death had been working on many important improvements to radio apparatus.

The government is at last going to look into the situation that nightly threatens the pleasure of many thousands of radio listeners, namely, the interference caused by scores of ship telegraph stations. Heretofore uninformed broadcast listeners, enraged by interference, blamed it upon amateurs. The amateurs co-operated in every way. Now it is up to the Department of Commerce officials to regulate the ships.

Let's Make This a Merry Radio Christmas

Greatest Radio Show Ever Held

Second Annual Affair at Coliseum, Chicago, Surpassed All Previous Records for Attendance and Exhibits

THE Chicago Radio Show, which closed a successful week on Sunday night, November 25, was the largest exhibition ever attempted. More than 130 national exhibitors occupied booths upon the floor of the Coliseum, and all available space was filled with radio apparatus, ranging from tiny head sets to fourteen-tube superheterodyne receivers.

The immense hall was decorated with American flags, and the booths were partitioned with decorative panels in white and gold, many of them fitted with stained glass transparencies. Although the largest crowd that ever attended any show ever held in the Coliseum was on hand nightly, the aisles were sufficiently wide to take care of them without crowding, so well were the booths arranged.

MANAGER JAMES KERR stated to a RADIO TOPICS representative that the show was even greater than he contemplated. The attendance was beyond all expectation, and national exhibitors took every available foot of space, certifying that Chicago is the radio center of the world.

Amateur Contests

One of the features of the radio show was the amateur contests conducted by the Radio Show Company. Many cash prizes were offered and all kinds of sets were on display, from crystal receivers to a fourteen tube outfit. One curious looking set was mounted on the frame of a bicycle wheel, the loop aerial being wound around the rim and the set constructed so that the owner can swing the entire outfit over his shoulder and hear music while riding or walking along the street.

Maurice Francille demonstrated the radio control of war ships on a platform at one end of the Coliseum, and special programs were broadcast all week by the various large stations in Chicago. There was no confusion, however, with a clashing of loud speakers from every booth. Many loud speakers were on display, but were si-

lent. The only reception permitted in the hall was under the direct supervision of the management and consisted of amplified receiving sets hidden on the balcony and attached to loud speakers in perfect synchronization.



Dr. Lee DeForest, famous scientist, his wife and daughter, who visited the Radio Show at Chicago. Dr. DeForest spoke from station WDAP Nov. 22 and Mrs. DeForest sang several soprano selections.

"Topics" at the Show

ONE of the most attractive booths at the Chicago Radio Show was the one occupied by Radio Topics. A miniature ship representing the Bowdoin frozen in the ice up along the coast of Greenland, flashing messages to the U. S. A. was inclosed in a shadow box and attracted hundreds of radio fans, who stood about and read the code. The novel exhibit was the handiwork of Gustave Ehrler of the Ehrler Radio Company.

Many Exhibitors Present

Following is a list of those who occupied booths at the show:

A. C. Electric Manufacturing Co., Dayton, Ohio; Acme Apparatus Co., Cambridge, Mass.; Adams Morgan Co., Upper Montclair, N. J.; Alden Manufacturing Co., Springfield, Mass.; Harry Alter & Co., Chicago, Ill.; American Radio Journal, New York, N. Y.; American Radio Relay League; Frank A. D. Andrea, New York, N. Y.; Atwater-Kent Manufacturing Co., Philadelphia, Pa.; Apco Manufacturing Co., Providence, R. I.; Harry Atwell, official photographer, registration booth; Auburn Button Works, Auburn, N. Y.; Auto Elec. Devices Co., Cincinnati, Ohio; Nathaniel Baldwin, Inc., Salt Lake City, Utah; Barsook Company, Chicago, Ill.; Bemo Radio Corp., Philadelphia, Pa.; L. S. Brach Mfg. Co., Newark N. J.; C. Brandes, Inc., New York, N. Y.; Bremer-Tully Mfg. Co., Chicago, Ill.; Bristol Co., Waterbury, Conn.; Buell Manufacturing Co., Chicago, Ill.; Burgess Battery Co., Chicago, Ill.; Carbon Products Co., Lancaster, Ohio.; Carter Radio Co., Chicago, Ill.; Chicago Association of Commerce, Chicago Board of Trade, Chicago Daily Journal, Chicago Daily News, Chicago Evening American, Chicago, Ill.; Chicago Herald and Examiner, Chicago Radio Apparatus Co., Chicago, Ill.; Columbia Radio Corp., Chicago, Ill.;

Commonwealth Battery Service Co., Chicago, Ill.; Commonwealth Edison Co., Chicago, Ill.; Coyne Electrical School, Chicago, Ill.; Crosley Mfg. Co., Cincinnati, O.; Cutting-Wash. Radio Corp., Minneapolis, Minn.; Dalton Whittier True Co., Chicago, Ill.; DeForest Ra. T. & T. Co., Jersey City, N. J.; Dictograph Products Corp., New York, N. Y.; Direct Sales Company, Chicago, Ill.; Doherty-Hafner Co., Chicago, Ill.; Dubilier Cond. and Rad. Corp., New York, N. Y.; Eisemann Magneto Corp., New York, N. Y.; Ekko Company, Chicago, Ill.; Elec. Research Labs., Chicago, Ill.; Everett Radio Co., Chicago, Ill.; Fansteel Products Co., North Chicago, Ill.; Fed. Tel. & Tel. Co., Buffalo, N. Y.; Foote Mineral Co., Philadelphia, Pa.; French Bat. and Carbon Co., Madison, Wis.; Herbert H. Frost, Chicago, Ill.; Garod Corporation, Newark, N. J.; Gilfillan Brothers, Kansas City, Mo.; Th. Goldschmidt Corp., New York, N. Y.; Granite Art Products Co., Milwaukee, Wis.; A. H. Grebe & Co., Richmond Hill, N. Y.; Howard Radio Company, Chicago, Ill.; Hudson-Ross, Chicago, Ill.; Inland Electric Co., Chicago, Ill.; Jefferson Electric Mfg. Co., Chicago, Ill.; Jewell Elec. Instrument Co., Chicago, Ill.; Howard B. Jones, Chicago, Ill.; Jones Radio Co., Chicago, Ill.; Kellogg Switch & Sup. Co., Chicago, Ill.; Colin B. Kennedy Corp., St. Louis, Mo.; Lefax, Inc., Chicago, Ill.; Levitan Manufacturing Co., Chicago, Ill.; Lynn G. Lindsay, Minneapolis, Minn.; Lynn Radio Co., Chicago, Ill.; Lytton Radio Co., Chicago, Ill.; Marco Meyer & Co., Chicago, Ill.; Marinette Elec. Co., Marinette, Wis.; Mitchell Blair Co., Chicago, Ill.; R. Mitchell Co., Boston, Mass.; Monroe Manufacturing Co., Chicago, Ill.; Moon Radio Corp., Long Island City, N. Y.; Multiple Electric Products Co., Newark, N. J. Nat'l Carbon Co., Long Island City, N. Y.; The Henry M. Neely Publishing Co., Philadelphia, Pa.; Neon Lamp Works, New York, N. Y.; O'Neil Mfg. Co., West New York, N. J.; Operadio Corporation, Chicago, Ill.; Penpurthy Injector Co., Perfection Battery Co., Chicago; Philadelphia Storage Battery Co., Philadelphia, Pa.; Popular Radio, New York, N. Y.; Post Office, Precision Equipment Co., Cincin-

Prizes Given

There were more than 300,000 replies received to the Listeners Vote contest staged by the three broadcasting stations in Chicago and the management of the Radio Show. Every night during the second annual show, two names were drawn from a large hopper, and each one received a valuable prize, ranging from \$250 receiving sets down to jacks and tubes. These prizes are to be mailed the week following the show.

nati, Ohio; Premier Electric Co., Chicago, Ill.; Press Room, Radio Magazine, San Francisco, Calif.; Radio Age, Chicago, Ill.; Radio Digest, Chicago, Ill.; Radio Pro. Mfg. Co., Chicago, Ill.; Radio Stores Corp., New York, N. Y.; Radio Topics, Oak Park, Ill.; Radio World, New York, N. Y.; Rauland Mfg. Co., Chicago, Ill.; Reliance Radio Sales Co., Chicago, Ill.; H. G. Saal Company, Chicago, Ill.; Signal Electric Co., Menominee, Mich.; Stackhouse and Allen, Chicago, Ill.; Sterling Mfg. Co., Cleveland, Ohio; Thordarson Elec. Mfg. Co., Chicago, Ill.; J. S. Timmons Talker, Philadelphia, Pa.; Trimm Radio Mfg. Co., Chicago, Ill.; United Mfg. and Dist. Co., Chicago, Ill.; Veriton Radio Assn., Chicago, Ill.;



Powel Crosley, Jr., of Cincinnati, who was in attendance at Chicago Radio Show.

Walbert Mfg. Co., Chicago, Ill.; Walnut Electric Mfg. Co., Chicago, Ill.; Wernes and Patch, Chicago, Ill.; Western Coil and Elec. Co., Racine, Wis.; Western Union Telegraph, Weston Electrical Inst. Co., Newark, N. J.; Willard Storage Battery Co., Cleveland, Ohio; Winkler-Reichmann Co., Chicago, Ill.; Wireless Age, New York; David A. Wright Corp., Chicago, Ill.; Zenith Radio Corp., Chicago, Ill.; Zinke Company, Chicago, Ill.

In point of attendance it was the largest Radio Show ever held, more than 400,000 persons having entered the Coliseum during the exhibit.

Notables Attend

E. T. Flewelling addressed the fans on his new "super" hook-up and Dr. Lee DeForest, inventor of the audion tube, also spoke before the immense crowds.

Dr. DeForest Attends Radio Show

DR. LEE DeFOREST, inventor of the audion, on which the entire art of modern radio and broadcasting is founded, attended the radio show at Chicago.

A good deal of sentimental interest was attached to his trip there. It was in Chicago that Dr. DeForest made the accidental discovery that led to the discovery of the audion. That was in 1901. He had only been out of college a few years and was working days for \$8 a week and at night sought practical solutions for his theories in wireless.

Quite by accident one night in his boarding house he noticed that sound waves influenced the gas light in his room. That discovery started him on experiments which years later produced the three electrode vacuum tube, or audion as the inventor named it, and by which name all the radio fans know it.

WHAT could be more appropriate for the young man of the house than a radio set? Think of the hours of enjoyment he will get out of it.

And the whole family can enjoy it.

Let's make this a Merry radio Christmas.

Why Newspapers Broadcast

BY WILLIAM S. HEDGES

WMAQ, Chicago Daily News, Chicago

FIFTY newspapers in various parts of America are operating their own broadcasting stations. In addition to this number there are 100 newspapers which have some sort of affiliation with broadcasting stations.

This evident interest on the part of newspapers in broadcasting is perhaps significant of an evolution in journalism. There are few subjects that hold more interest than the growth of journalism to its present high state, but I shall not take your time here to trace the history of newspapers from 1498, when the first newspaper was issued. It will suffice to refer to the great contribution of telegraphy to journalism and the subsequent creation of the great news services, which are spread like nets about the globe, ready to report news events with such rapidity that the whole world knows within a few hours events that are transpiring in distant countries.

With the Japanese holocaust still fresh in our memories, we have an example of that strange, new thing—radio—and what it can do for journalism. Were it not for the radio link between America and Japan, you can merely speculate as to the frenzy of Americans awaiting belated word from their relatives and friends in that country, so suddenly cut off from all cable communication. You who know the effect of world events upon financial conditions at home can imagine the flurry in the stock exchanges caused by uncertainty. Thus in assisting the newspapers in furnishing speedy news to the public, the whole public is benefited.

Radio a Big Factor

I am, of course, mentioning a phase of radio, with which but few of the members of the National Association of Broadcasters have to deal. Yet, it clearly points the way to progressive newspapers and newspapermen that they must be thinking in terms of a great social development, when they are building the future of their publications.

The cubs of today will be the managing editors of tomorrow.

When they reach that estate they will in all probability have to deal with that great voice—radio—which may be made a power of vast good to the republic or a power of destruction and disintegration. That is a responsibility that all broadcasters face.

But why should newspapers become broadcasters? That is a question that undoubtedly reiterates itself in the minds of everyone of the newspapers engaged in the operation of their own stations. It is natural for manufacturers of radio equipment to broadcast. They are sustaining the reason for the purchase of their product. For the same reason retailers find broadcasting worthwhile, even though these two classes of broadcasting are paying the freight for the manufacturer who won't participate in the expense of entertaining the public.

Why Colleges Broadcast

Schools and colleges broadcast because they wish to extend their influence, to increase their enrollment, through the advertisement

of their name and their wares, or they may operate stations as mere demonstrations of their physics departments.

But why should newspapers broadcast? There are several practical reasons. I will mention them first. But there is also an idealistic reason. Among the practical reasons is the creation of good will, an intangible, yet nevertheless invaluable asset for quasi-public institutions, such as newspapers. Dollars may not directly follow from the pleasures experienced by listeners to programs broadcast by newspapers, but the feeling of friendliness is there and the friendship of the masses makes strength for the newspaper.

It has been said that a newspaper has a harder time advertising itself than any other firm or institution. The other firms and institutions can run their advertising in the newspaper in order that they may reach their clientele and attract new patrons through its own medium.



EXECUTIVES OF NATIONAL BROADCASTERS' ASSOCIATION

Left to right, C. H. Handerson, WJAX, Cleveland; Raymond Walker, manager Bureau of Music Release; Senator Frank W. Elliott, WOC, Davenport; Eugene MacDonald, Jr., WJAZ, Chicago; Paul B. Klugh, ex-chairman; William S. Hedges, WMAQ, Chicago; J. Elliott Jenkins, WDAP, Chicago; C. B. Cooper, Department of Commerce, radio committee; John Shepard III, WNAC, Boston. Seated, Powel Crosley, Jr., WLW, Cincinnati, taken at recent convention at Commodore Hotel, New York City. Over 4,284 telegrams were received within four hours in answer to request to determine size of listening audience at one station. It was estimated about one in one hundred sent telegrams. (Photo by Wide World).

It can advertise in other newspapers in the same city, but that is too often a confession of its own weakness. So we find the newspapers advertising in billboards, placed in conspicuous places. The power of billboard advertising is a debatable matter.

With the advent of radio, the newspapers have a new medium of advertising, though, of course, it is indirect. Through radio the name of the newspaper, engaged in broadcasting, is poured into the ears of thousands of listeners, and without offense. Through radio the various departments of the newspaper become known. The automobile editor, with his talks on traffic regulation or on motor trails, makes his department known to the public and such of the public as are interested in automobiles, traffic rules and motor highways will turn to their radio friend's column for information. The broadcasting of football, baseball and other sporting returns, emphasizes the efficiency of the sport department. Similarly, in giving a service to the public, the newspaper is building up its clientele.

A radio department in conjunction with broadcasting also serves the public, which seeks to learn the nature of the program to be broadcast. The fan may learn how to build his set by reading the radio pages and will feel kindly to the newspaper which has helped him. He can then tune in on the newspaper's station and get the entertainment he seeks. He takes his troubles to the newspaper and comes to regard it as a friend and counselor. Such friends may be counted in the circulation tabulations.

Some of these reasons for a newspaper entering into broadcasting may not seem as cold-bloodedly commercial as the word practical suggests, but newspapers do not gain their strength from being cold-blooded in its contacts with the public. There must be the willingness to serve as the inspiring motive behind the ceaseless labor of presenting the facts as they are found.

When a newspaper goes onto the air, the spoken word of the radio station is as representative of the newspaper as its pages and columns. For that reason the same policies should prevail in broadcasting as pertain in the editorial content of the paper.



Sidney Kasindorf, well-known amateur, New York, whose call letters are 2-ATV, showing panel arrangement of his three circuit honeycomb regenerative receiver. He has covered long distances with this receiver, he says, and for neatness of design and simplicity of control it would be hard to beat this outfit. (K. & H. Photo)

Hawaiians Hear WHB's Program

RADIO listeners in the Hawaiian Islands have for some time had the pleasure of listening to programs from "the good old U. S. A.," re-broadcast from the station of the Honolulu "Advertiser." Usually these programs come from KHJ and KFI, both in Los Angeles and both equipped with Western Electric 500 watt transmitters.

On the night of September 2, a new record was made with the re-broadcasting of a late program from WHB, the Sweeney Automobile School at Kansas City. This station is also equipped with a 500 watt Western Electric transmitter and its well known slogan, "The Heart of America," has been heard from coast to coast. On this particular occasion the engineer in charge of the Hawaiian station said that WHB's signal strength was ex-

ceptionally good and its modulation perfect.

The re-broadcasting arrangement is as follows: At the Koko Head station twelve miles from Honolulu, is a receiver consisting of three stages of radio frequency and a standard short wave set, fed from a combination of a Beverage and horizontal antenna. The signal is then amplified with one stage of audio frequency and one stage power amplification, and passed through twelve miles of telephone line to the City of Honolulu, where it is put into the modulating circuit of the Honolulu "Advertiser's" transmitter (KGU). The distant signal thus actuates the local station and provides coast programs to the enthusiasts in the Islands of the Hawaiian group.

TIPPING MOTHER OFF

Mrs. Upstart—On this invitation to the Highbrows' affair I see R. S. V. P. I wonder what that means?

Daughter—Why, you silly thing; I suppose they are going to have a radio concert from that station!—New York Globe.

The Future of Radio Broadcasting

By *MARTIN PRICE*

Director of Broadcasting for the General Electric Co.

ELECTRICITY as a servant of man was almost unknown fifty years ago and its conspicuous achievements in lighting, traction, power, ship propulsion, and communication are all within recent years. So the word "electric" has almost become a synonym for speed, progress and accomplishment. Unlike other new developments which are frequently held back by their own limitations, the progress of electric application is limited chiefly by human inertia and conservatism.

Thus while the incandescent lamp was invented by Edison in 1879 and has since been so perfected that it furnishes the best light available and more economically than kerosene or candles, yet it is now used in less than half the houses in the United States.

Electric locomotives capable of exerting greater power than any steam locomotive and operating so efficiently as to save enormously in coal consumption have been available for many years, yet only two per cent of our railroad mileage has been electrified. The complete utilization of water power which is practicable through electrification would be a tremendous factor in conserving our country's fuel resources, yet only one-fifth of our available water power has been developed.

Radio Is Exception

In spite of the great strides which electricity has made, we must admit that with one notable exception, we have been relatively slow in realizing its full possibilities. The notable exception is, of course, radio broadcasting. Never in the history of the world has any invention been so eagerly, so rapidly, and so universally adopted.

Three years ago it was an almost unknown art. Today there are six hundred broadcasting stations, and the receiving sets are numbered in millions. As a method of communication it has taken its place with the telephone, telegraph and post office, but it is

more than a method of communication. With the printing press and the moving picture, it is one of the three greatest factors in forming and influencing public opinion.

What of the future of this marvelous invention which makes it possible for a speaker to address an audience of millions, reproducing sound so faithfully that a whisper or the rustle of a sheet of manuscript is projected hundreds of miles and so rapidly that the voice may be heard across the continent before it reaches a hearer at the end of the room?

Future of Radio

Forecasts may be of two kinds: first, the natural and logical developments of an art according to its known principles and laws, and, second, the imaginary extension of the art beyond these limits, and we may readily, although reluctantly, dispose of the latter by predicting that the most fanciful flights of the imagination are probably inadequate pictures of the future of radio just as the fairy tales of the last century fell short of the actual accomplish-

ments of the present day. In other words, we may consider the future of broadcasting as an economic force rather than try to foretell how invention may add to its further development.

The ability to communicate instantly and simultaneously with millions of people is not a power which will be lightly discarded as a fad or a passing fancy. It suggests, with no strain on the imagination, a universal language and the vehicle for complete mutual understanding among the peoples of all civilized nations.

Music is a universal language and fortunately music is the foundation of all broadcasting today. Undoubtedly it will continue to occupy an important part of the programs, but it will be used with more artistic taste. The best in music will always be available so that public appreciation will become more exacting and the inferior and mediocre will be eliminated.

Great Educational Factor

To music will be added the radio play, a form of drama introduced by WGY at Schenectady,



FRIEND OF BRONX RADIO FANS

This is Leo Johnson, who operates amateur radio station 2-CTQ. He has just completed a new 20-watt transmitter, shown herewith. Four 5-watt Radiotron tubes are used and the station on test has covered great distances on this low power. Mr. Johnson lives in the Bronx, New York City, and there is no more popular amateur in the East. On the left is a three step regenerative receiver. (H. & H. Photo)

having characteristics as distinctive in the radio field as the screened play in moving pictures, but preserving at the same time the complete realization of literary form.

Religious services will continue to inspire the vast radio audiences and particularly to cheer and comfort those who are incapacitated through age or infirmity. In spirit they will assemble regularly "to meet the Lord in the air," and there will grow up a religion in which shades of creed will be subordinated to belief in great fundamental principles. Then there will be established a unity of religious peoples which has never before existed.

Graded educational courses will be available at times convenient to those who labor in factories or fields so that the world's educational standards may be greatly advanced by providing opportunities even for those isolated from educational centers or otherwise prevented from attending school and college.

The use of radio for broadcasting news, market, stock and weather reports will be greatly extended, supplementing these functions of telephone, telegraph and newspaper.

A Serious Problem

These are some of the obvious developments of radio broadcasting which may be expected in the immediate future as they do not demand any radical advance in our present technical knowledge. They do, however, necessitate some consideration of the question: "Who will undertake to broadcast?" because broadcasting today involves a serious responsibility. Whether broadcasting develops along the line of its technical possibilities or remains stationary depends largely on those who undertake the job. The inquiry is particularly pertinent now when a score or more broadcasting stations are relinquishing their licenses every month and about an equal number of new stations are coming "on the air." This condition, which was predicted a year ago, results largely from a lack of understanding as

to the cost and responsibility of broadcasting.

A modern, well equipped high-power station costs not less than \$150,000, and the annual cost of operation is approximately \$100,000. Obviously a department store, newspaper, or other enterprise supported largely by local trade, cannot afford to broadcast far outside of the area it serves. Such stations will naturally be short-lived unless they limit themselves to low power and short programs. Even then it is probable that better results for all concerned would be obtained in such cases by renting broadcasting facilities from those established to render such service.

Fewer Stations

We may therefore assume that the number of broadcasting stations will decrease rather than increase, and that the high power stations with daily programs will be operated by interests of national scope. The Radio Corporation of America and the great electrical manufacturing companies will continue to broadcast on a large and expensive scale because the sale of receiving sets is dependent on the continuance of good broadcasting and also be-

cause of the friendly relations which broadcasting may establish with the public.

Another development worthy of mention is the distribution of broadcasting over telephone or electric lighting systems. This plan is entirely practicable and may be employed to a considerable extent in metropolitan areas, but will never supersede general broadcasting. The one quality of radio broadcasting which has gripped public interest is its universal freedom. It reaches everywhere and is free for all who supply themselves with receiving sets.

Thus, while broadcasting involves an enormous expense without any direct returns, it may be expected to continue on an improved and more comprehensive plan, becoming an established means of disseminating news, music, education, entertainment and religious services. Fortunately most of the important broadcasting stations are quite conscious of the great responsibility they have accepted and they are seriously studying the problems involved with the views of rendering the listening public a real and permanent service.



RADIO MOVIES THE LATEST THRILL

According to announcement of an invention recently perfected by Harry Herzog, a young inventor of 437 Lafayette avenue, Brooklyn, N. Y., you can sit in your parlor and watch wireless movies on your home screen from a nearby broadcasting station. Mr. Herzog recently demonstrated his invention to his backer, Abraham Goodman, in his home. The photo shows the inventor standing beside his wireless receiver, declared to be a "fool proof" radio outfit with no aerial, no ground and only one dial, with a radius of 1,000 miles. (Photo by International Newsreel.)

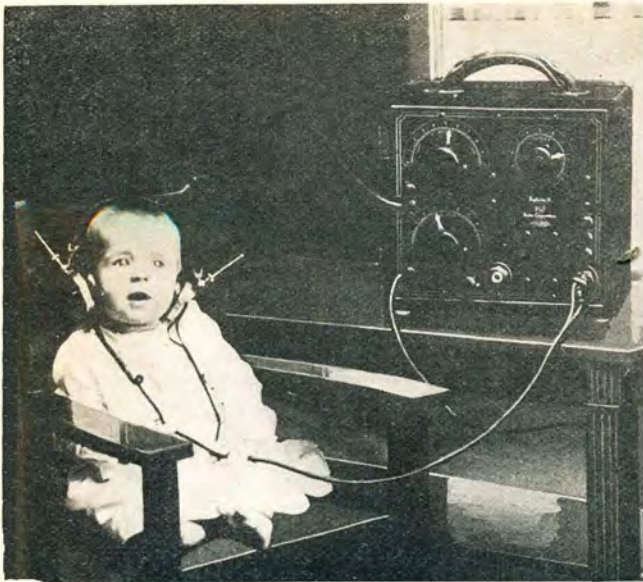

Here's Wallace Gordon Yadon of Delavan, Wis., familiarly known as the "WGY" kid, the first baby to be named after a broadcasting station. He's listening to the General Electric station at Schenectady right now.



M. W. Obermuller's receiver utilizes three stages of transformer coupled radio frequency, detector and two stages of audio frequency. It has but one control, aside from the rheostats and one potentiometer. The efficient workmanship is probably responsible for the fact that Mr. Obermuller has brought in stations far distant and no squeals are encountered in tuning. (K. & H. Photo)



G. H. Frohman has equipped his Rolls Royce with a receiving loop and Western Electric loud speaker and is giving the baseball fans a treat outside the stadium grounds during the recent world's series. WEAJ is broadcasting.

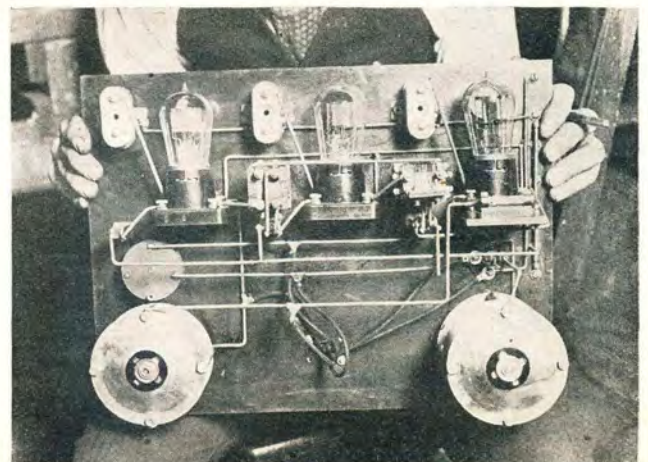

A well designed three circuit regenerative receiver. Back view of Sidney Kasindorf's three circuit honeycomb set. Note the neat wiring and arrangement of parts. A receiver built like this is sure to get DX. (K. & H. Photo)

Essentials of Good Reception

By ALPHONSO PAUL

WHEN radio broadcasting was first initiated, the government was at a loss which wavelength to assign these new stations. All wavelengths were constantly being used excepting one of the lower of the three which are assigned to the commercial land and ship stations. This wavelength happened to be 360 meters lying between the amateur wavelength of 200 meters and the usual commercial wavelength of 600 meters. At this wavelength the broadcasting of programs would also create the least interference for all the stations.

As everyone knows, after broadcasting became popular and such a great number of stations were operating on the same wavelength, it became impossible, even with the best of instruments, for the receiving station to enjoy any one program without the interference of another. Accordingly, the Department of Commerce undertook to improve the situation by assigning a different operating wavelength to each station. This solution helped considerably until the number of stations, steadily increasing, has now reached that point where many of the allotted waves vary not more than 3 meters. Some stations, located in the same city, vary only $\frac{1}{2}$ meter. Such a close variance causes the present situation to be nearly as bad as when all the broadcasting stations were operating on the same wave, for on the average receiving set, 10 meters in tuning makes very little difference.

* * * *

Reception of programs free from interference is now up to the receiving station, its instrument, and general equipment besides the ability of the operator. The receiving instruments must be highly sensitive and selective as well as simple in operation. Manufacturers are beginning to realize that such an instrument is an absolute necessity. The day of the numerous multi-control receiving set, although sensitive and selective, which took an expert to tune, is past.

Outside of the tuned plate impedance radio-frequency type of

receiver, a well constructed regenerative receiver is the best for simplicity of control combined with sharpness in tuning. In such circuits, the plate, as well as the grid circuit, is tuned to the incoming signal. In other words, before it is possible for the desired signal to be heard, not only must the antenna-ground and grid-filament circuits be in resonance with it, but also the plate circuit. It is the tuning of the plate circuit which causes the regenerative type to excel over the simple circuit tube receiver in selectivity.

Receivers built according to the instructions given by Mr. Paul A. Perry in the August, September, and October issues of RADIO TOPICS have proven to be very selective as well as easily controlled. In each of the hook-ups given in Mr. Perry's articles, it will be found that the plate circuit of the tube is separately tuned to the incoming wave which accounts for their good selectivity.

* * *

It must not be expected that a good receiving outfit will separate stations under any condition. Correctly designed and built antennae have much to do with efficient reception. If the natural period of the antennae has too great a fundamental wavelength, it is practically impossible for any instrument to tune in stations whose wavelengths are less than that of the receiving antenna.

Altho it has been proven that the large antenna absorbs more of the transmitting energy, thus producing a greater current in the antenna tuning circuit than is possible to obtain with a small one, it must be remembered that such an antenna is also broad in tuning. Because of this greater absorption ability, the tuning out of static and interfering stations is very difficult. Also when receiving antennae are placed at great heights, the signal strength and static interference increases while the tuning broadens considerably.

On the other hand, a small antenna placed at a moderate height, may be easily and sharply tuned

and, because of its lower static ratio, is less effected by static interference. Of course the original signal energy absorption of the smaller antenna is somewhat less, but, if necessary, this may be overcome by proper amplification.

Thus the best receiving antenna is one which is moderate in length (under 100 feet) placed at a moderate height (from 25 to 40 feet) and, if composed of more than one wire, with wires well spaced (from 18 to 36 inches) with all connections tightly soldered. Attic antennae usually follow these dimensions closely because of lack of room in both height and length. For this reason, the usual attic antenna will be found to give equal or better results than obtained on a huge one outdoors.

More essential than a good antenna for perfect reception, is a good ground connection. From the many poor "grounds" to be seen, one would believe the average amateur to be afraid of them. Water pipes make good ground connections when properly used. A fairly heavy wire should be used for the ground and fastened securely to a spot where all paint and rust have been removed and the bare metal of the pipe cleanly scraped. Many meters contain rubber washers in their connections which act as insulators and break the electrical continuity of the pipe line. Therefore, the best water pipe ground is that which is securely fastened to the feed pipe on the street side of the meter.

Many of the minor general equipment details in the receiving station which are now unstudied and overlooked by the operator, must soon be corrected or the selective ability of his station in receiving great distances, as it has accomplished in the past, will be greatly reduced. The great number of broadcasting stations now in constant operation, with the continuous inception of the many more that are soon to come, presents a serious problem in overcoming interference and the operator who wishes to enjoy the consistent long distant reception of the past will be forced to give due consideration and study to details, which before now, were looked upon with indifference.

Practical Hints on Designing of Regenerative Receivers

By PAUL A. PERRY

PART 7—THE DX BRINGER-IN

ALL radio fans have dreamed of the day when they could own or build a radio receiver which would be easily operated, sharp in tuning, and highly sensitive in order that they could receive long distant stations without "fishing" forever and then only to be disappointed. Every receiver, so far, has had its good and bad points, but always has succumbed to the objections. This receiver, however, seems to have been able to keep its good points far ahead of any of the objections. Its efficiency over both wavelength range and distance have proven to be very gratifying in its tests.

Using only the one tube, this circuit has repeatedly received stations 1,500 miles and more distant. It is more easily tuned than most receivers because of the absence of all switches. Just the adjustment of the three dials in tuning simplifies the receiver to a large degree. There is no constant fear of forgetting the relative positions of the all important switches.

One may keep a record of the dial positions, and if the station is transmitting, may tune it in by only setting the dials at their recorded positions. Of course, as this receiver is of the regenerative type, times will occur when the carrier waves of other stations will necessitate a small variation from the recorded adjustments, but one may be sure that the records will not be off more than a few per cent.

Tuned Plate Circuit

The classification of this circuit under any one of the established types is an impossibility. It makes use of the tuned plate circuit, as in the double circuit regenerative, by use of the variometer and an inductive feed-back action from the variometer and secondary into the primary similar to the single circuit regenerative. There is also a conductive

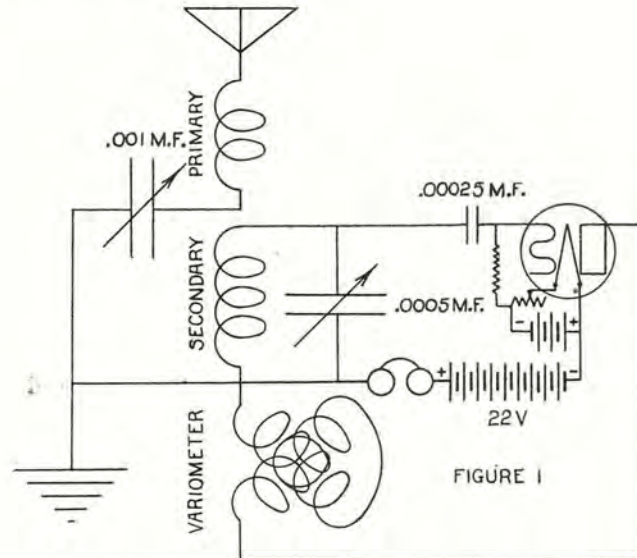

Hook-up of DX Receiver described in accompanying article

regenerative effect caused by the plate variometer being directly connected to the secondary. Thus regeneration is obtained by really two distinct methods of induction and conduction.

The only name by which this circuit is known is that of the "DX Bringer-In." This descriptive name was given it because of its unusual ability as a one tube circuit in distant reception, and no other name seems to have been necessary to increase its popularity.

As will be noticed from the diagram in figure 1, the antenna-ground circuit is tuned only by means of a small fixed inductance and a .001 M. F. (43 plate) variable condenser placed in series with it and the ground. This condenser is also placed that it will also be between the secondary and primary coils thereby enabling the secondary to be grounded directly.

Fixed Inductance

The secondary circuit consists only of a fixed inductance tuned by means of a .0005 M. F. (23 plate) variable condenser connected across it. One side of the

secondary inductance is connected to the ground and one side of the plate variometer stator winding.

It is this connection which provides the conductively coupled regeneration.

The regeneration of the tube is controlled by tuning the plate circuit with the variometer. The tuning inductances viz: the primary, secondary, and variometer are made up into one unit as in figure 2. Both the primary and secondary coils are wound on a tube $3\frac{1}{2}$ inches in diameter and about 4 inches long that is mounted next to the variometer stator winding as shown.

For the best results, choose a variometer whose coils consist of not more than 40 turns each of number 18 double cotton covered wire. Smaller sizes and more turns of wire will cause the adjustment of regeneration to be very critical. The primary coil consists of 20 turns of number 18 double cotton covered wire wound on that end of the tube farthest from the variometer stator. After skipping a space of $\frac{1}{8}$ inch, the secondary, consisting of 50 turns

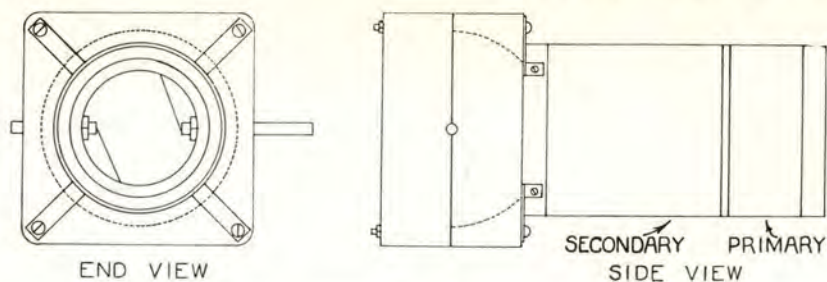

FIGURE 2

Two views of the coil used in accompanying article by Paul A. Perry.

of the same sized wire, is wound into place. When winding the coils, be sure that they, including the variometer stator winding, are wound in the same direction similar to one continuous coil. If one coil should be in opposition with the others, poor reception will result. These combinations of coils and condensers will easily respond to wavelengths of 175-600 meters, which will more than cover the needs of the broadcast receptor.

How to Wire Parts

When the unit is completed, the parts are wired as shown in figure 1. Care should be exercised to keep the unit and condensers well spaced in order to guard against any counter inductive currents which might cause the set to howl. Be sure that the rotary plates of both variable condensers are connected to the ground lead of the circuit. If these connections should be accidentally reversed, very noticeable "hand effect" will interfere with the tuning.

The grid-leak is connected from the grid side of the grid condenser to the negative side of the filament battery and not across the grid condenser as is usual. For best reception, its reception should be fixed at 2 meg-ohms.

In tuning, the primary variable condenser is set about three-fourths of the way in and the variometer set at about 15 or 20 degrees. The secondary variable condenser is then adjusted until the desired station is heard, after which the variometer is turned until maximum regeneration is obtained. If the secondary variable condenser is critical in its adjustment, which is an indication of not quite being on the wave, the primary condenser should be adjusted until the signals have been increased to their greatest intensity. Such a re-ad-

justment of the primary condenser will tend to broaden the adjustments of the secondary condenser, but should do so without impairing the tuning ability of the circuit.

Commissioner Issues Aerial Rule

Following the tragic death of two men in Chicago while erecting an aerial one Sunday morning, John T. Miller, commissioner of gas and electricity of Chicago, has issued the following warning for the guidance of persons erecting aeri-als:

Do not attach radio antenna wires to electric light or telephone poles in alleys or streets.

Do not cross radio antenna wires over or under electric light or telephone wires.

So locate radio antenna wires that if they should break, any broken wire will not come in contact with electric light or power wires.

Supports for radio antenna wires should be very substantial, particularly so on account of the coming winter weather.

Particular attention should be given to the location of radio antenna wires, so that in case wires fall they will not fall on pedestrians.

"The development of the radio has been so rapid that it is exceedingly difficult to draft a set of hard and fast rules," the commissioner said. "I fully realize the difficulties, but the growing popularity of the radio demands immediate action."

Let's make this a radio Christmas. Considerable interest has been created by the two big radio shows in Chicago and New York, and radio week added to the success of a radio Christmas.

Can You Write a Scenario?

DR. LEE DeFOREST wants to know whether there are any scenario writers among the radio fans.

He intends to produce a radio comedy via the Phonofilm and said he would be mighty gratified to receive suggestions from the radio fans all over the country. Just to make it more interesting, he will give one of the new D-10 reflex sets as a reward for the best radio comedy scenario submitted, provided it is available in the Phonofilm studio.

Lest there be any radio fans who are unfamiliar with the Phonofilm it should be stated that the Phonofilm is a combination of motion pictures and voice or music or any other sound the action calls for. It is all photographed and reproduced in absolute synchronization. Many people call it "talking pictures."

Dr. DeForest believes that a most hilarious comedy can be made on the Phonofilm by taking radio as a subject and he knows no better source of suggestion than the radio fans themselves.

Scenarios should be sent direct to Dr. Lee DeForest, 220 West Forty-second street, New York City.

Farmers Not Slow to Adopt Radio

The speed with which farmers have taken up radio for practical and social purposes is shown in recent survey made by the United States department of agriculture.

County agricultural agents estimate that there are approximately 40,000 radio sets on farms in 780 counties. This is an average of 51 sets per county. Applying the average to 2,850 agricultural counties a total of more than 145,000 sets on farms throughout the country is estimated.

The county agents' estimates cover every state. In New York it is estimated that in 37 agricultural counties there are 5,502 sets on farms. In 51 counties in Texas there are 3,085 sets. Forty-three counties in Illinois show 2,814 sets; 26 counties in Missouri, 2,861 sets; 42 counties in Ohio, 2,620 sets; 40 counties in Iowa, 2,463 sets, and 26 counties in Kansas, 2,054 sets.

Reaching Across Oceans With Radio

By E. F. W. ALEXANDERSON

Chief Engineer, Radio Corporation of America

(Abstract of An Interesting Paper Read Before the American Institute of Electrical Engineers)

THE radio engineer is, more than any other, compelled to work with conditions which are not within his control, and only partially understood. The law of probability and average must therefore figure largely in his calculations.

A good many of those present here are undoubtedly radio amateurs. When you have received some clear signals from Kansas or Cuba this is an interesting fact and you relate it to your friends. Many of you are no doubt fond of fishing especially when you have caught a big trout. That is an event worth mentioning. These are single facts highly subject to the law of chance. Nevertheless the professional fishermen succeed in providing fish for our dinner tables with great regularity. It is the aim of the radio engineer to charter the sea of the ether, to weather its storms and to provide a continuous service of communication day and night.

The transoceanic radio station is a power station. Its input is kilowatts and its output is words. The problem of radio engineering is to establish the relation between kilowatts input and words output. This relation between kilowatts and words is a chain comprising four separate subjects which are being studied by specialists in those subjects.

* * *

They are:

1. Relation between kilowatts consumed and wave energy radiated.
2. Relation between wave energy at the transmitting station and wave energy at the receiving station.
3. Relation between wave energy at the receiving station and the speed at which words can be received.
4. Influence of atmospheric disturbances.

The first subject deals with the radio power station and the an-

tenna. The Radio Central antenna is designed from the ground up. It has six ground connections distributed over a distance of one mile and 150 miles of wire buried in the ground. Through these devices the ground resistance has been reduced to 1/10 ohm. The best antenna of types previously used have ground resistances of about two ohms. The losses in the ground have thus been reduced at the rate of 20 to 1.

The second subject is wave propagation. We have now a great deal of practical data which can be summed up in the rule that the most economical wavelength for communication over a certain distance is about one five-hundredths of the distance.

The third subject deals with the design of the receiving station. It has been found that the speed in words per minute at which it is

possible to receive telegraph code is directly proportional to the amplitude of the waves. A signal field strength of 50 microvolts per meter corresponds under average conditions to a speed of 50 words per minute.

The fourth subject deals with the atmospheric disturbances. Our modern receiving system eliminates about 9/10 of the disturbances but the residual which is not eliminated determines the speed of reception by the law of inverse proportionality.

For elimination of disturbances we use a new type of antenna about ten miles long. It is a simple telegraph wire mounted on ordinary poles. It is not tuned for any particular frequency, and waves of all lengths travel along the wire with the velocity of light. The ether wave thus starts a wave on one end of the wire, and this wave travels along the wire while



KEEPS IN TOUCH WITH THE GIANT DIRIGIBLE—ZR-1

A photo of the naval radio station, Lakehurst, N. J., which receives and sends reports to the ZR-1. This home station is in constant touch with the dirigible. It uses a navy type set with three stages of frequency, detector and two stages audio frequency amplification. The signals—both CW and telephone—come in loud and clear as a bell, it is said. (Kadel & Herbert News Photo.)

the original ether wave follows beside it in space, constantly adding energy to the wave on the wire, just as the wind starts a ripple at one shore of a lake and rolls it up to a large wave as it travels along. Thus the wave intensity in the wire grows and becomes a maximum at the far end of the wire. Fortunately on the Atlantic coast most of the disturbances come from the West, whereas the signals come from the East. The wave antenna thus separates the signal from the disturbance so that the signal appears at the east end of the wire and the disturbance at the west end. The energy of the disturbance is destroyed by absorption in a resistance at the west end of the wire, whereas a practically pure signal can be collected at the east end.

With the data that is thus available, the planning of a new radio system is no longer a matter of guesswork. Before designing our South American system we sent an expedition of engineers to chart the atmospheric disturbances. Their findings led to a modification of the original plan because it was discovered that at the location first selected the principal disturbances came from the same direction as the signal, and therefore could not be eliminated. From the data now available it is possible to calculate the number of words that can be received during each month in the year, although the stations have not yet been built.

We can thus say that radio engineering has reached a point where sound foundations both technically and financially can be laid for the expansion of this system of communication.

Martin New Manager

The appointment of E. W. Martin as Chicago district manager has just been announced by the Valley Electric Company, St. Louis, manufacturers of Valley Radio Battery Chargers and other electrical products.

Mr. Martin comes to the Valley organization from the Westinghouse Electric & Manufacturing Company, with which he has been associated for a number of years in various capacities.

The appointment of C. L. Krentz in the sales department of the Chicago office is also announced by the Valley Electric Company.

Radio Endorsed by Movie Man

JUST as the advent of the motion picture was looked upon by the operators of the legitimate theater as a menace to their welfare and business future, so the coming of the radio into thousands of homes is regarded as a menace by some of the producers and distributors of motion pictures.

In one of the largest producing-distributing concerns in New York, radio is taboo. Any reference to radio or the showing of this form of amusement is strictly avoided in their productions, and the publicity department is not allowed to mention it in any of the copy which leaves their hands.

Other distributors of motion pictures have accepted the radio in the same manner in which the far-seeing theater operators saw the movies—as a new form of amusement and disseminator of entertainment and knowledge to thousands in a form which was so different from their productions as to be a negligible factor in their business.

Mr. E. W. Hammons, president of the Educational Film Exchanges, Inc., has just installed in his home in New Rochelle, N. Y., a radio receiver of the most improved type, a four tube reflex receiver which brings to his home the programs of half of the United States, and is an ardent radio fan.

"I do not consider radio a menace to the future of the motion picture industry," said Mr. Hammons at a recent convention of branch managers of the Educational Film Exchanges, at which the radio set was presented to him by the exchange managers. "Radio appeals only to the ear; motion pictures appeal to the eye. Literature—books, magazines, and all other amusement forms of fiction—perhaps consume more of the public's time than either the movies, radio or the legitimate stage, but no one has regarded it as a menace, nor did publishers regard the advent of movies or radio as inimical to their interests.

"I will say, however, that radio will compel the motion picture theater operator to pay more attention to programs he sets before his patrons. People will listen to good music from the air rather than sit through a poor motion picture program, and motion picture programs will need to be selected with greater thought. Good comedy and novelty

subjects add spice and variety to the program; it is these short subjects which give the program the diversity that will offset any tendency on the part of the public to forsake their motion picture entertainment in favor of the radio."

Care of "B" Battery Important

THE "B" battery is the source of life of your set. Many radio fans do not realize this and still think the "A" battery is the source of the signal, but as a matter of fact the only purpose of the "A" battery is to heat the filament so that the "B" battery current may flow.

The purpose of the vacuum tube is to vary the "B" battery current in accordance with the received electrical impulses. It is this modulated "B" battery current that passes through your receivers and produces the sounds you hear. It is "B" battery current which travels through the windings of the transformers and flows from tube to tube and finally through the receivers.

The life of a "B" battery depends on the battery itself (quality, size and age) and on the use (number of tubes, hours of daily use, strength of signal desired).

Each battery consists of a number of cells, all alike, each of which gives a maximum of about $1\frac{1}{2}$ volts. Fifteen such cells are used in a $22\frac{1}{2}$ -volt battery, thirty in a 45-volt, sixty in a 90-volt and so on. The battery is good or bad only as these cells are good or bad. The size of these cells (which determines the dimensions of the battery) is proportional to their energy. The bigger they are the longer their life and the greater their energy. The large size $22\frac{1}{2}$ -volt battery will last six times as long as the small size, but costs only twice as much. Buy the largest dimension "B" battery obtainable in a standard make.

The more tubes you use and the greater the length of time you use them at once, the greater is the drain on the "B" battery. The kind of tube and the voltage of the "B" battery applied affect the life of the batteries. Use the lowest "B" voltage on each tube that gives satisfaction. On R. F. tubes, particularly, do not apply the full A. F. voltage just because it is available. Use as low as 45 volts if it gives results.

Last, but not least, have the proper negative bias from a "C" battery applied to each amplifier tube. This will cut down the current flow from the "B" battery to less than a third of the flow without it and will give just as much volume with greater clearness.

Let's make this a radio Christmas. Considerable interest has been created by the two big radio shows in Chicago and New York, and radio week added to the success of a radio Christmas.

Department of RADIO ENGINEERING

Radio Topics Institute

NANKO C. BOS, Chairman Advisory Board



Look for the Approval Seal

Such as the one just above which are furnished manufacturers whose radio merchandise has been tested and approved by the Institute Laboratory. We urge you to purchase only such apparatus, for it carries the guarantee of our organization.

Send all inquiries and material for test, calibration, or reconstruction to RADIO TOPICS INSTITUTE, Oak Park, Ill.

How to Build a Good Audio-Frequency Amplifier

By EDSON CALDWELL

BECAUSE of the trigger action of the grid in a tube it may be made to amplify at both radio and audio frequencies. Audio-frequency amplification is the easier of the two to accomplish, but even then is not as easy as many manufacturers paint it to be. Such amplification consists of much more than just connecting some transformers and sockets together and placing the whole in a cabinet. Good judgment in the choice of materials and in designing and the placing of the units in relation to each other.

Many have been led to believe that the transformer is the reason for the greater increase in volume and power through an amplifier and that the greater the turn ratio between the primary and secondary windings, the greater will be that power. However, the amplification of the signal is done by the tube and the transformer is used only as a means of coupling and at the same time impressing a slightly higher voltage upon the grid of the following tube. If the

turn ratio is very great, the resistance of its winding will eat up all the energy which is being passed into the amplifier. In fact, the turn ratio of a transformer in radio work does not mean much—if anything.

Difference in Transformers

For an example, one maker of transformers uses 1,500 turns in

the primary winding and 6,000 turns in the secondary, which, by the turn ratio computation, gives a step-up ratio of 4-1. Another firm, using the same size core, puts 2,000 turns in the primary winding and 8,000 turns in the secondary, which also gives a step-up ratio of 4-1 by the turn ratio method of computation.

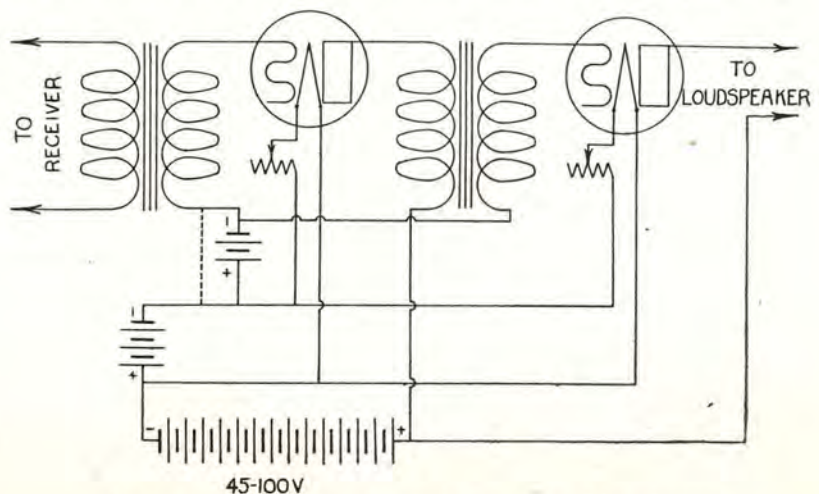

Audio Frequency Amplifier described in article by Edson Caldwell.

However, the direct current resistance and impedance values of the two transformers, both having a 4-1 turns ratio, are entirely different. In fact, because of the different impedance values, different amplification, or volume, will result from amplifiers built from the two different transformers. Therefore, when purchasing amplifying transformers obtain only those whose impedance values for both primary and secondary windings are given. When desiring two of the same character, be guided only by these values. The values of different makes will differ, but if the values of the transformers are given, one may be sure that the maker has exerted every effort to build a better product.

Some manufacturers build what is known as a 9-1 or a 10-1 ratio transformer, making the radio fan believe that these higher ratios would result in a greater amplification. However, because of the greater increase in the resistance of the secondary winding, all the energy is eaten up trying to overcome losses so that in the end the high ratio transformer cannot and will not amplify as well as a lower ratio. Oftentimes the high ratio transformer is worse than nothing because of its consumption of that energy which is most wanted and its seeming ability to introduce more outside noises than the lower ratio types for a given volume.

Care in Buying

In choosing the transformer, particular attention should also be paid to the insulation, especially in the "shielded" types, around and about the terminals or binding posts. Since the inception of the "shielded" type of transformer, there has been much trouble from noisy and often inoperative amplifiers caused by leakage or short circuits around the binding posts. Many of the "shielded" transformers use only thin fibre or bakelite washers for insulating the terminals carrying the high frequency currents.

It must be remembered that high frequency currents are always hard to insulate for no material known seems able to entirely stop their progress and when the terminals of a transformer, which is constantly using such currents, are only separated from

each other by not more than 1/16 inch of material which is not even considered a good insulator, it will be seen how useless it is to expect much power amplification when such a transformer is used. Just the least microphonic leak, not detectable with direct current or even with sensitive headphones, will let through enough high frequency currents to result in noise, howling, and possibly a short circuit.

The core of any transformer is placed as it is to aid in the transference of the energy from the primary to the secondary. The impulses of the primary energy are partially absorbed by the core which in turn sets up a magnetic flux, or magnetic lines of force, which follow the core in a circular form, and cut the secondary winding at right angles, inducing the current into it. As the winding becomes larger in diameter, more magnetic lines are cut, thereby increasing the induced voltage. In this way a greater voltage output will be found at the outside connection of the secondary than possible to obtain at the inside connection.

In electrical vernacular, the outside connections of the windings are called the "high" sides and the inside leads or beginning of the coil, are called the "low" sides. These names are used to designate which sides of the coils produce the greater voltages.

Audio Frequency Transformers

In building the audio-frequency amplifier, be sure to always connect the plate of the preceding tube to the "high" side of the primary and the grid of the next tube to the "high" side of the secondary.

The positive "B" battery should be connected to the "low" side of the primary while the "low" side of the secondary is connected to the negative side of the filament battery. By doing this, the grid of the next amplifier will be impressed with the highest voltage obtainable from the transformer secondary while at the same time it is kept negative by connecting the "low" side of the winding to the negative "A" battery. This method of wiring is the only one which will produce the highest possible amplification.

Because of the susceptibility of their products to howling, many

manufacturers have reversed the connections as given above. By reversing them, much noise and howling are cut down, but, so is any energy, including signals, which happens to be passing through the transformers. If care is used in placing the transformers, no trouble will result when the plates and grids of the tubes are connected to the "high" sides of the windings as they should be.

Any good make of transformer will give good results if connected as shown in the accompanying diagram. Transformers whose primary direct current resistance is about 1,100 ohms with an impedance of 50,000 ohms at 1,000 cycles and whose secondary direct current resistance is about 5,000 ohms with an impedance of 600,000 ohms at 1,000 cycles, are recommended. Such a transformer has a winding ratio of about 3.5-1.

The rheostats should be connected in the negative lead, as shown, in order to give the effect of a biasing "C" battery. When very great volume is required and plate voltages of over 50 are used, a "C" battery of from 2 to 10 volts, made up of flashlight cells, to keep the grids negative, is recommended to be placed as shown in the diagram. If lower plate voltages are to be used, simply forget about the "C" battery and connect the "low" side of the secondary directly to the negative lead of the "A" battery as shown by the dotted line around the "C" battery.

In mounting the transformers, place them at least one inch apart with the cores preferably at right angles or parallel but not in a line with each other. When so placed, one will not be bothered by howling caused by the magnetic interference from the cores.

Testing Condensers

A short circuit in a fixed condenser or variable condenser may be easily detected by aid of a dry cell and telephone receiver. If a loud click is heard in the phones when placed in series with the condenser, it is a sure sign that the condenser is short circuited somewhere. Usually in the variable type this can be easily detected by looking over the plates to find out where one plate is touching another.

CORRESPONDENCE WITH THE INSTITUTE

THIS department is conducted by Paul A. Perry, Technical Editor, RADIO TOPICS. Any inquiries addressed to him will be answered promptly, provided stamped and self-addressed envelope is enclosed with inquiry.

Please make your questions as concise or brief as possible.

This is your department. Use it freely.

TECHNICAL EDITOR, RADIO TOPICS,
1114 North Boulevard, Oak Park, Ill.

I have a DeForest M. R. 6 Radiophone and wish to add one step of Radio Frequency Amplification. I have been advised that transformer coupled R. F. will not give satisfactory results with regeneration and was told to use the hookup as shown in the enclosed drawing. However, I am not certain that this will give good results and would appreciate your opinion of same before I go ahead with the job. The condensers shown are the regular DeForest condensers used in the set and the inductances are the 3 D. L. Coils. Am told that this should tune very sharply and make the set more sensitive.

With present hookup (detector and 2 Audio) the sets get fair distance and volume, but do not seem to do better than about 1,000 miles on available aerial equipment. Expect R. F. to increase this distance considerably.

Any information will be greatly appreciated.—J. R. P., Milwaukee, Wis.

ANSWER: Transformer coupled radio frequency will not give the results that impedance coupling will when amplification is wanted. The diagram you sent us is correct excepting the "B" battery connections. You had 90 volts on the detector tube. We are returning the

diagram with the necessary corrections. The antenna-ground coil should be verifiable in the amount of inductance in the circuit. We suggest that it consist of 80 turns of No. 22 double cotton covered wire wound on a tube 3½ inches in diameter with taps taken off every 10 turns. Also that the variable condensers be of the 23 plate size. This circuit will greatly increase your present range and also sharpen your present tuning of the set. If you wish, you may use the same "B" battery for both radio and audio-frequency amplifiers. This type of circuit has been thoroughly tested and used by us and we assure you that you need have no hesitancy in going ahead and building one.

Although a reader of your interesting magazine for almost two years I am sending my first request for technical information and hope you may find it convenient to put me right.

Can the "Hazeltine Neutrodyne" principle of radio frequency amplification be applied to a "Grebe CR-5 and Rork" combination? If so, please send me diagram and list of material necessary to make this addition.

Thanking you in advance and assur-

ing you that I am an enthusiastic reader of RADIO TOPICS, I am C. F. D., Bismarck, N. D.

ANSWER: Because of the great difference in the units and materials used we would not advise trying changing the Grebe CR-5 and Rork into a Hazeltine Neutrodyne. You cannot use the same units and, if attempted, it would be necessary for you to completely rebuild the Grebe set. If time were considered at all it would be very much in your favor if you would build the Neutrodyne set separately. By that we mean you would have to replace the panel with a new one because of the mounting screw holes not fitting the Neutrodyne units, even if you built them yourself, rewiring would be necessary, and possibly you could not get the units in such small space. We would not try to remodel the Grebe set, but build an entirely new one. The Hazeltine principle cannot be applied to any receiver excepting those using transformer coupled radio-frequency, which is tuned with variable condensers. The Hazeltine principle is only the neutralizing effect, obtained with the use of the small condensers, which is designed to keep the radio-frequency amplifiers from oscillating.

I would appreciate it very much if you will send me a little diagram showing how I can connect a potentiometer onto a Westinghouse DA tuner without disturbing the AF transformers or the RF units, which I also have.

I am operating radio combination units models RT, RA, AR and DA and want to connect a potentiometer onto the detector alone.

If you can help me out I will be very much obliged.—E. H., St. Louis, Mo.

ANSWER: It will be a pretty hard job to insert a potentiometer in your Westinghouse unit set without disturbing the parts. Usually these sets will not operate any better with a potentiometer placed in them. Therefore, we do not recommend your placing one in the circuit. However, if you wish to place one in it, connect the winding of the potentiometer across the "A" battery and the wiper to the ground of the tuner. In doing this the ground is dis-

The Row Family Buys a Radio



connected from its usual place leading directly to the filament of the tube, but the potentiometer just takes the place of this connection so there is nothing to worry about ruining the set. The potentiometer just enables you to adjust the polarity of the grid of the radio-frequency amplifier. In operation you will find out the best operating point is the negative side so that a potentiometer will make very little difference in your present reception.

I have been a reader of your grand magazine about as early as it started and I sure do enjoy it.

I am now puzzled over what simple circuit to use with a WD-11 tube. Can you please instruct me as to which one to use and what instruments—that is what make of instrument would be used to get best results. I want the best circuit you know for distance and clearness.—B. B., Milwaukee, Wis.

ANSWER: The circuit given on pages 19 and 20 of the October, 1923, issue of RADIO TOPICS is an excellent one for use with any tube. It was especially designed for operation with the WD-11 and WD-12 tubes. If you wish to build one you can easily do it by following those instructions or you can buy the unit and assemble the set. We regret that this department cannot recommend which makes of parts to use but a diligent perusal of the advertising columns of RADIO TOPICS, especially the October issue, will give you the names of parts which have given very good results.

I thought I would write to you to see if you could give me a little information. Could you send me a good hookup for DX work using a variocoupler, one 23-plate variable condenser, one 43-plate condenser, one variometer in plate circuit. I use WD-11 tube and Western Electric aviation phones. Do you think this outfit is good for DX?

I would appreciate it if you would send me hookup. I have the set in a 7x18 cabinet. I have good parts, no cheap parts, so I think I ought to get a DX with a good hookup.—G. H., Jr., Paterson, N. J.

ANSWER: The circuit which we believe would prove very satisfactory to you appeared on page 25 of the September, 1923, issue of RADIO TOPICS. This circuit makes use of all the parts you have excepting the 43 plate variable condenser. Instead of constructing the tickler unit, as described in the above article, you may substitute your variocoupler by connecting the secondary as the rotor and using the primary as the stator and extra coil combined. The variometer is connected in the plate circuit, as we believe you wanted it. The 23 plate variable condenser is connected in the antenna circuit. The circuit as a whole has proven to be a very good one in receiving distance and in sharp tuning. We are sending you a copy of this issue in order that you may construct your set from the original data.

Radio for Whole Family

WE often talk about Christmas presents for individuals, but do we ever think about a present that will give happiness and entertainment to the entire family? A good radio receiving outfit will efficiently fill such a need. It is a pleasure to both the young and old, the sick or well, for it puts one in touch with all types of music, plays, world news, and that which very few of us have the opportunity to enjoy—grand opera.

In consideration of the fact that a radio receiving instrument produces only sound, it is a requisite that one chooses it as one would a good piano, violin, or, in fact, any musical instrument. Some are misled by others saying that a radio receiver will never have tone qualities, but these are ignorant as to the true receiving instrument. Perasco receivers, for instance, from the smallest to the largest, are built only for their tonal qualities and volume.

Have you ever visited a friend and seen him "tune in" a station, and when he removes his hand the station fades into the distance and the instrument begins to make all sorts of unearthly squalls? This defect is due to the original faulty design of the instrument which makes it susceptible to the capacity effect of the body. Certain radio receiving circuits are remarkably free from this "body effect" and these are the only ones which are permitted to be used in any of the Perasco instruments.

Tube noises are also a very serious detriment in the long distant receiving of any instrument. Stations may be heard but the voices are not understandable and you only know their presence by that little squeak which often warns you of their proximity. However, through the correct use of the units which compose any receiving instrument, these undesirable noises can be eliminated entirely.

Perasco engineers have worked unceasingly to build the Perasco instruments entirely free from such annoyances and, to the surprise of all, have succeeded.

The little Kewpie set is the most popular of the whole series of Perasco instruments. This is, without doubt, due to its extremely high quality and low price. The radio market cannot produce an instrument that will compare favorably with it, nor one with such a combination of perfect performance, adaptability, design, or workmanship at its price.

Excellence of materials and workmanship have not been sacrificed in order to produce a moderately priced instrument, and in return for the great care exercised throughout its manufacture, one is repaid by its uninterrupted service and long life. Reports from Kewpie users have been very gratifying for those whose ambition has been to produce "The Better Radio." Many who were skeptical as to its performance and purchased one for only local reception have found it to bring in stations such as Pittsburgh, Jefferson City, Mo.; St. Louis, Mo.; Kansas City, Mo.; Detroit, Mich., and other stations located within a radius of 1,000 miles from this vicinity (near Chicago, Illinois) with equal ease and clarity as the local stations. These users are the best advertisers of the Kewpie that the company could wish for, and are the highest compliments which any manufacturer may be given.

For those who prefer a loud speaker to the headphones, procure an amplifier, known as type PA-III, which matches the Kewpie in design and steps up the received energy so that the stations may be heard over the whole house. Any signal which the Kewpie receives will be intensified to the same volume clearly and without distortion. Amplifying transformers of all types and grades have been tested to find which would give the best universal results, and only after much work was the correct type found. The designing of the Kewpie and its amplifying unit alone took more than a year's time in research before perfection was reached. Without doubt, each stands for perfection of its class.

The Perasco Petit-Grand is especially built for those who are

(Continued on page 35)

How to Build a Real DX Set

By L. H. HALLGREN, R. E.

SINCE radio broadcasting was originated many types of receiving circuits have come to fame, some have remained in the hall of fame, while others have passed away. Some of them being single, and others two, three and four circuits all of which have been declared excellent.

For the beginner with little or no experience the single circuit is the one recommended. This type will give excellent long distance results, with good volume and clarity. It is simple to tune, having but three controls.

The circuit described in this article employs two well known features, the first being the sharply tuned primary inductance which in this case functions as a wave trap. The second is the tuned plate, by means of the tickler coil. Very fine tuning is afforded by the vernier plate on the detector tube and the vernier plate on the variable condenser.

It will be noted that the construction of this set is so simple that any one can with little or no experience can build it. The necessary parts are as follows:

- 1—7"x18"x3/16" panel
- 1—16"x17"x1/2" base board
- 1—Vernier rheostat 6 ohm for U. V. 200 or C. 300;—30 ohm for U. V. 199 C 299 or U. V. 201A or C 301A.
- 2—Plain rheostats.
 - 1—C. R. L. grid leak (variable)
 - 1—.00025 grid condenser
 - 1—Single circuit phone jack
 - 2—Double circuit phone jacks
 - 3—Standard sockets.
- 1—180° varicoupler
- 1—.0005 cap. 23 pl. variable condenser.
- 1—Switch lever
- 10—Switch points
- 2—Switch stops
- 8—Binding posts

Approximately 25 ft. No. 14 tinned bare copper wire.

The hardest part is the drilling of the panel. This is where care must be exercised.

First on a piece of heavy paper or cardboard, the exact size of the panel, lay out in pencil the locations of the particular apparatus you have selected.

On the left side of the paper 3/4" from the edge draw a line from the top of the panel to the bottom. Then 3/4" from the top edge make a cross, (x) and likewise from the bottom edge. These are for the antenna and ground posts.

Then at the right end draw another line 3/4" from the right edge and mark two crosses in the same position as on the left. Then on the same line 1 3/8" up from the bottom cross make another cross and 1 3/8" from this make a third cross and then 1 3/8" from the third make a fourth cross. These are for the binding posts and 3/4" of an inch to the left of right end top post or cross make a fifth cross. These two top posts are for a loud speaker connection. All of the 8 binding posts should now be located.

Next at the bottom of the paper draw a line (hor.) 7/8" from the bottom edge. Make a first cross 1 1/2" from the right edge and another 3" from the first and one 3" from the second. These are the locations for the three jacks.

Next 3 inches from the bottom edge draw another line parallel to the first line. Then 3 inches from the right edge make a cross; 3 inches from it make a cross and 3 inches from the second make a third cross. These are the rheostats locations. The mounting screw hole centers for the rheostats are not given because of different types in manufacture.

Next 2 inches from the top edge draw a line clear across the paper. Directly above each rheo-

stat on this line make a cross. These are the centers for the light peepholes. Now take a pencil compass and set it for 3/4 inch radius. Now draw a circle around each of these crosses. Then divide these circles in sectors with the same radius. You will then have seven crosses for each lamp. Then in the remaining space place crosses to accommodate the variable condenser on the extreme left and next to it on the right the centers for the coupler. Different types require different centers, therefore they can not be given here. The switch lever and switch points can be placed in space convenient to coupler on layout. The number of points or taps used will vary according to types on the market. Two switch sets give closer tuning. The variable grid leak should be placed on the layout as close to the detector tube socket as possible.

Now take the paper and slightly glue it to the panel and with a sharp center punch, punch every cross (+) into the panel.

You are now ready to drill the panel. Sharp drills are advised and the panel should be placed on a flat board while drilling. This will prevent the drill from chipping the back of the panel when it cuts through.

The drill sizes are recommended as follows: Binding posts No. 18, condenser and coupler shafts 5/16 inch or 3/8 inch—switch lever center hole 5/16 inch and the points 5/32 inch or 1/8 inch. The peep holes 3/16 inch. The switch point centers should be set at 3/8 inch; rheostat 5/16 center holes.

After the panel is drilled mount all the apparatus on the panel and you are ready to wire the panel. The location of other apparatus is shown in the drawings. Look at the circuit and note which wires will come on the bottom and put these in first. In building a house the roof is never built first. If this hint is remembered much work that seems hard will be easy.

In wiring the set up care must be taken not to get the grid and plate circuits too close together

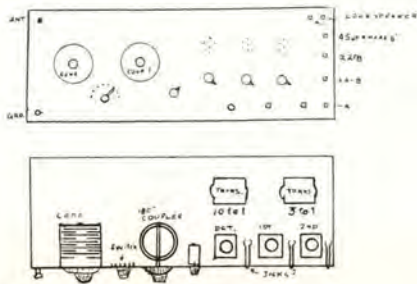

(Top) Panel layout of circuit described in accompanying article. (Bottom) Floor layout showing detector and two stages, 180 deg. couplet and condenser.

as this will cause trouble not easy to locate. When you are sure all the panel wiring is completed, mount the panel to the baseboard and proceed wiring the jacks, transformers, etc.

It must be remembered that the jacks seem troublesome and more so than they really are. If you will follow this simple ruling there will be no trouble. The +B battery feed must come to the lower spring of the jack and to the second from the bottom must come the lead from (+B) on the transformer. The third from the bottom must be connected to (P) on the transformer and the fourth or top spring to (P) on the tube socket. Make all the wiring as short as possible trying to keep each run $\frac{1}{4}$ inch or so apart from a parallel run or crossed run.

Then all you have to do when wiring is completed is to tune in "Long Distance" and you have the U. S. A. at your finger tips. Do not advance the rotor of the coupler too far as the point of regeneration will be too great and cause howling. First set your sw. lever on a point where you think the range you wish is covered. For most stations about 40 to 45 turns from (Ant. to Grd.) on the primary of the coupler. Now rotate the condenser till a whistle is heard. Then turn the ticker coil (Sec.) of coupler slowly until the whistle turns to music or voice. Then go to your vernier plate on the condenser and turn back and forth slowly and—well you may be listening to the stations in Los Angeles, California, who knows? The tube for long distance should be burned less bright than for local stations. This is important and should be regulated to each station for clarity. Also use lower "B" battery voltage on the plate of the detector tube for distant stations.

The writer has built and experimented with almost every new circuit but has found this one to do more under handicaps than any other. California KFI was tuned in clearly against the Chicago stations, using only the detector tube. New York, Dallas, Texas, Fort Worth, Omaha, Kansas City, St. Louis, Minneapolis and Birmingham, Ala., have all been heard on the loud speaker using the three tubes.

This may sound fishy but the only way to be convinced is to

build it. Do it today and listen in on any night to long distance.

All of the above stations were heard on a 40 foot inside aerial as I have no outside aerial. Without any ground or aerial connected to the set, on the three tubes Chicago can be tuned in on the horn.

A New and Practical Grid Leak

THE Allen-Bradley Co. of Milwaukee, Wisconsin, manufacturers of the Universal Bradleystat and Bradleyometer, have added another item to their line of graphite disc radio products.

The new device is an adjustable grid leak known as the Bradleyleak which was developed to meet the insistent demand for a high-grade, dependable grid leak. It is similar in external appearance to the Universal Bradleystat and is equipped with an adjusting knob which conforms in general design with the approved tapered knob now used in most radio equipment



New Bradleyleak

and matches perfectly with the adjusting knobs of the Bradleystat and Bradleyometer.

The Bradleyleak can be adjusted between the limits of 250,000 ohms and 10,000,000 ohms or, as usually stated, between $\frac{1}{4}$ megohm and 10 megohms. The entire range of grid leak resistance between these limits is instantly obtainable without noises, steps or jumps by simply turning the adjusting knob. It is a significant fact that all intermediate values of resistance can be accurately obtained at any time which is a feature not often found in many types of adjustable grid leaks.

The Bradleyleak is claimed to be very accurate and a desirable

addition to any radio set and makes possible the accurate adjustment of grid leak resistance for any tube used as a detector circuit.

The base of the Bradleyleak is recessed to receive a small fixed condenser which is furnished as an extra attachment, if desired. The grid condenser is accurately adjusted to a capacity of .00025 microfarads.

We'll Bite—When?

WHEN does the radio fan sleep?

This question is being asked by officials of the Willard Storage Battery Company which recently opened its powerful new broadcasting station at Cleveland, Ohio. They have good reason for wondering about the nocturnal activities of radio fans for this company while testing out its transmitting apparatus every night for a month previous to opening regularly, received thousands of letters from night-owl radio fans.

In order to have the air at a time when no other stations were broadcasting, it was found necessary to test after midnight. Accordingly, WTAM, the call letters assigned to the new Willard station, tested either shortly after midnight or from five to eight o'clock in the morning. As the station was merely testing, it used its former amateur call letters, 8XG, and asked all who heard the programs to write in as to the quality of their reception.

Willard officials knew that they would get many such reports but did not anticipate the flood of them which literally poured in from all over the United States and Canada. Many radio fans over a thousand miles distant from the broadcasting station, not knowing that they were receiving from one of the most powerful stations yet built expressed their curiosity as to what equipment the amateur station was using to get such distance.

The mystery was finally solved for them, however, when Willard began broadcasting regular programs on Wednesday and Saturday evenings, using the newly assigned call letters WTAM.

But the question still remains—when do radio fans get their required sleep?

Does the Crystal Set Broadcast?

By PAUL GREEN

THE fact that the regenerative set under certain conditions does cause interference seems to have been pretty definitely established. But it is very rare indeed, that we hear of a complaint of interference caused by the non-regenerative set. Generally speaking, the subject of non-interference in this case is practically as well established as interference in the other. Admitting these grounds, there would seem, therefore, to be no reason for suspecting that a crystal set can broadcast. With the number of apartment house roofs equipped with radio antenna ever on the increase, the problem of aerial interference becomes more and more complex. In discussing whether a crystal set can cause interference (much less broadcast) the experience of Mr. W. M. Graham, technical director on the staff of the Atlas Educational Film Company of Oak Park, Ill., is of exceeding interest.

Mr. Graham, a man of very extensive technical training, especially with radio, in which case it dates back to the early days, is expecting to start work on a fascinating series of radio films within a short time. While the use of films in connection with other industries is becoming greater and greater and such films have formed a large part of the Atlas Company's work, yet the possibilities presented in radio motion picture films (through a novel plan) as outlined to a representative of RADIO TOPICS by Mr. C. A. Rehm, secretary of the Atlas Educational Film Company, are almost limitless.

Heretofore apparently unsurmountable obstacles have been encountered because of the apparent inability to find a film director of sufficient technical training to properly analyze and interpret for the assimilation of the layman. That Mr. Graham is amply qualified is well indicated by the following:

I had developed what I believed to be quite a successful single tube regenerative set. In building it I had made use of all my past experience. It was a case of developing the single tube set to a state of highest efficiency with best modulation rather than working for volume. The greatest fascination lay in determining how large a range the set would cover. During the last several months, the set which prior to that time had given excellent service, appeared to develop freakish temperament. Some fac-

tor was present which had not existed before.

Aerial Interference

Investigation proved that a neighbor below had installed an aerial on the same roof with mine. Nothing more serious, however, can be found on the other end of the "lead-in" than a single crystal set—the two aerials were reasonably well separated. In spite of this, all sorts of noises of the open circuit type were experienced. So much for the conditions.

No attempt will be made at this time, at least, to lay claim to whether or not a crystal set can

broadcast by virtue of energy which may be developed in its own circuits. Checks which were used in arriving at the solution of the difficulty will perhaps prove of interest and value to other radio fans and as to how the freakish effects were obtained—well, you can judge as to that for yourself.

The work on my present single tube regenerative set was begun long before my 25 apartment neighbors got the fever. Therefore, the problem of erecting a well designed, generous aerial was a simple one. No interference was experienced. The antenna stood well alone on the big flat roof. But you can imagine my anxiety when the janitor was seen to ascend roofward with a coil of stranded copper and the familiar porcelain insulators. Realizing the spaciousness of the roof and taking at their face value the earnest assurances of the janitor that the new aerial would be placed quite far from mine, I hoped that no ill effects would be experienced.

Everything went well for a few days. Then I began to notice a periodic decrease in the volume of reception, especially in the case of the more distant stations. As these were the very ones in which I was most interested and on which I spent the most time, the problem of locating the interference became imperative. Everyone knows the exasperating experience of trying to get a telephone number, only to hear the open circuit noise of a phone out of commission. Imagine the same condition as applied to radio and you can picture my state of mind when, upon getting a station nicely tuned in, to hear it fade entirely out and perhaps in its place to hear ghostly noises which could by no stretch of imagination originate in a regularly constituted broadcasting station. Having spent practically my entire life with technical subjects, I soon found my mind as absorbed in the engrossing problem of finding the source of interference as I had



C. A. REHM

Secretary Atlas Educational Film Co.

been in tuning in on long distant stations. No one in the immediate vicinity had installed any electrical devices. The only radio receiver was the simple crystal set belonging to Mr. B. The character of his set seemed to preclude the remotest possibilities of interference from that source.

Tested Set Thoroughly

Therefore, at the outset, each piece of the apparatus comprising my simple WD11 set was scrutinized and tested. Other pieces of apparatus were substituted piece by piece, thus providing a double check. Still the source of annoyance was not removed. As it was only possible to spend leisure evening hours at this task, it naturally required a period of several days to complete the test. A summary of the findings revealed that the indistinguishable noises were in reality children's voices and what appeared to be microphone vibrations. These seemed to be present only at intervals when my set was receiving and consequently, when the WD was oscillating.

While this new interference was resisting investigation, I was searching every corner of my experience for a clew as to the cause. I became convinced that this noise was due to some other receiving set and decided in spite of everything to the contrary, to investigate the station on the roof myself, regardless of the janitor's earlier assurances, working on the theory that the trouble might be caused by the crystal set. The aerial, although crossing under mine, seemed to be at sufficient distance by all the rules of Hoyle, to eliminate any possibility of transmitting energy that might by a great stretch of imagination, be developed within a common home-made crystal outfit.

That a crystal set could radiate energy was a thing unheard of and I had scarcely the temerity to even suggest it to my wife. Certainly, however, Bell's early discoveries with the telephone dealt with energy from a very insignificant source and apparently conditions existed which in radio parlance were not unlike those encountered by Bell. The more I tried to assure myself that waves could not be picked up from a crystal set, the more I became convinced that these new noises

in reality originated in the headset of my neighbor's apparatus. As frequently is the case in apartments, we were not intimately acquainted with Mr. B's family. I then proceeded to interview Mr. B. after having worked out all details of a complete test with Mrs. Graham all tuned in to a musical program at 368 meters (here is a good tip for other radio fans experiencing interference). Anticipating the possibility of giving the wrong impression and antagonizing I pleaded guilty to the possibility of having created interference for him. Approached from this angle he became very much interested in getting information which would enable him to get more dependable reception. To my surprise he admitted to having gotten but little consistent service from his set since it had been installed in our building. What he had received, however, had been very clear and loud and required but little tuning.

Crystal Set Broadcasts

It was then mutually agreed to proceed with the series of tests which had been arranged with my wife, who, you will recall, was left listening in on my set. First, the diaphragm of B's receiver was gently tapped with a finger, as though to make sure it was free to vibrate. This little trick repeated with regularity was the first of several pre-arranged messages to be broadcast from the crystal. These signals were picked up by Mrs. Graham as an audio vibration, but considerably below the music in volume. This proved in a general way that the crystal set could be made to influence the tube set. Second, B was then instructed in a count test, he to speak

into one receiver, holding the other to his ear, counting at one second intervals, 1-2-3-etc. Having already gone to our own apartment, I picked up this counting as my wife had already done with the tapping. B's set was now unquestionably broadcasting voice. Now, the next point, could I broadcast and be picked up by B? A reversal of the second test, namely, the count test, holding my phones as had B in conjunction with the musical program heretofore spoken of as being received on my set on the 368-meter wavelength. Now that it was ascertained that each station could hear the other, it was found interesting to go one step further and establish a two-way conversation. It is quite common practice for telephone linemen to converse over the metallic circuit, using a receiver for microphone or transmitter. Since we now had the two sets equipped with high resistance receivers as transmitters, it was a simple matter to talk into one receiver while holding the other to the ear. This test also worked and we found ourselves able to converse quite clearly, but superimposed upon the music waves. You will remember that my set was working at 368 meters when the tests were begun and had not been changed up to this point, and the crystal set could not be adjusted to work on any other wavelength.

Now that it was no longer necessary to run up and down stairs to arrange the test, I slowly changed my set to an increasing wavelength while I carefully counted 1-2-3-etc., at one second intervals. This was so done that one second was allowed for each five degrees on the primary condenser. This test was extended over the entire range, or approximately from 300 to 500 meters. After counting backward to the 368 meter position at which setting conversation had already been carried on, a checking up with Mr. B. revealed that he had lost the music simultaneously with myself, as my set was changed from

(Continued on page 30)



NO HOME COMPLETE WITHOUT IT

Radio is discussed as much as books, plays and the movies, nowadays. Every sun parlor has one. This is a scene from the Atlas Educational Film Company's special feature film, "The Great Idea," a home beautiful picture produced at Oak Park, Ill.

New and Novel Radio Patents

RECEIVER SUPPORT FOR SOUND AMPLIFIERS

(Patent No. 1,469,941, issued to Charles W. Kuen, Chicago, Ill., under date of October 9, 1923.)

This invention relates to improvements in receiver supports for sound amplifiers, and it consists in the combinations, constructions and arrangements herein described and claimed.

An object of the invention is to provide a device of the character described in which means is provided for yieldably holding telephone receivers, such as used in a radiophone receiving set, and directing the sound waves therefrom to the amplifying horn of a phonograph or the like; a device which may quickly and easily be attached to the ordinary type of phonograph amplifying horn in place of the ordinary type of phonograph reproducer; a device which may be made of a single piece of stock, and which is relatively cheap to manufacture.

Figure 1 is a plan view of an embodiment of invention partially in section with one receiver in place, and

Figure 2 is a sectional view along the line 2-2 of Figure 1.

In carrying out the invention use is made of a Y-shaped tubular body member 1. The body member 1 and the remainder of the device, as hereinafter described, is composed of a partially vulcanized resilient rubber.

At each end of the shorter branches 2 and 3 of the body member 1 is provided an integral cup-shaped member 4. The members 4 are circular in shape and are centrally located upon the branches 2 and 3 of the body member 1. The bottom walls 5 of the members 4 are relatively thick, while the side wall 6 are relatively thin, and may be easily stretched. A rib 7 is provided at the outer edge of the members 4 for the purpose of reinforcing the side walls. The ribs 7 prevent the tearing of the side walls 6 as a telephone receiver, as shown at 8, is inserted within the member 4. The inner surface of the walls 5 is provided with an annular outwardly extending ridge 9. The ridges 9 are concentric the mouths 10 of the branches 2 and 3 of the body member 1.

The larger of the three legs of the body member 1, as shown at 11, is provided with an annular rabbeted portion 12 on the inner walls thereof. The purpose of the rabbeted portion 12 is to admit the mouth of a tone amplifying horn 13 of the phonograph or the like. The rabbeted portion further prevents the mouth 13 of the horn from being placed too far into the body member 1.

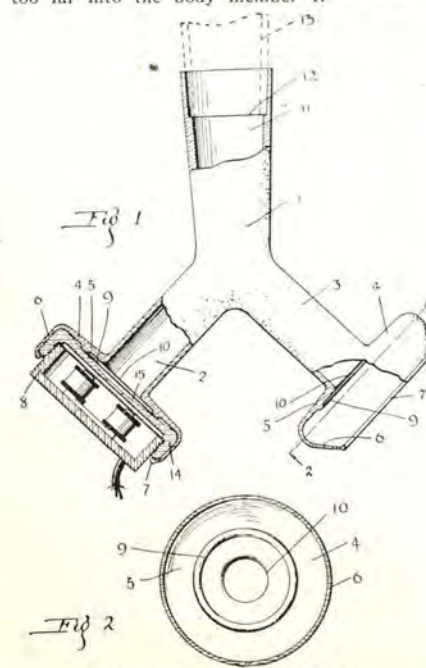

Receiver support for amplifier

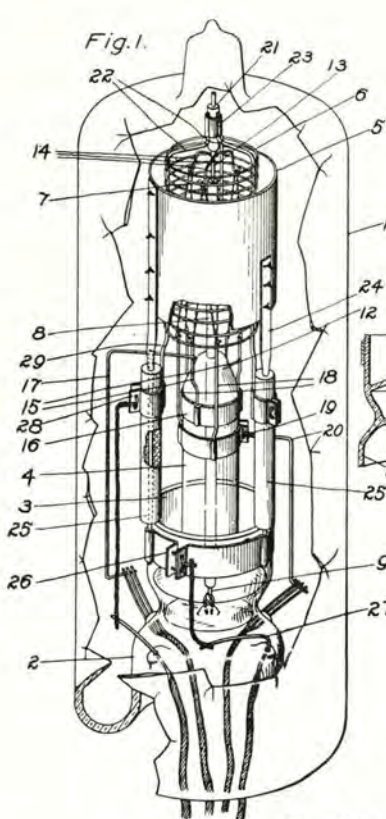

New Electron Discharge Device

ELECTRON-DISCHARGE DEVICE

(Patent No. 1,472,477, issued to Robert W. King of New York City, under date of Oct. 30, 1923.)

The invention relates to electron discharge devices, for instance, of the audion type, and particularly to devices of this type that are adapted for use with high voltages and large operating currents.

An object of the invention is to provide a more rugged mounting for the electrodes than is possible in case the usual glass rod or arbor is employed. This object is accomplished by using a supporting standard located centrally of the tube, the standard being preferably of insulating material, such as lavite which is stronger than glass, the electrodes being supported from this standard. This construction permits a wide separation of the leading-in wires which is advantageous in that leakage currents across or through the glass adjacent the sealing-in or supporting points of the lead wires are reduced to a minimum.

For further details of the invention, reference may be made to the drawings, in which Fig. 1 illustrates in perspective a vacuum tube embodying the invention, a single neck or stem on which the electrodes are mounted being employed; Fig. 2 is a cross-section view showing more in detail the manner of holding the lower end of the lavite supporting rod; Fig. 3 is a modification of Fig. 1 in which two inwardly projecting portions or stems are employed for supporting the electrodes.

Referring in detail to Fig. 1, the vacuum tube 1 is provided with the usual inwardly projecting stem or tubular portion 2, from which arises the concentric vitreous tubular portions 3 and 4.

The vacuum tube is illustrated as of the audion type comprising a cylindrical anode 5 having located therein the cylindrical grid 6 and the filamentary cathode 7. Centrally located within the tubular portion 4 and lying along the axis of the tube is a rod 8 of insulating material such as lavite. Located within

Fig. 3.

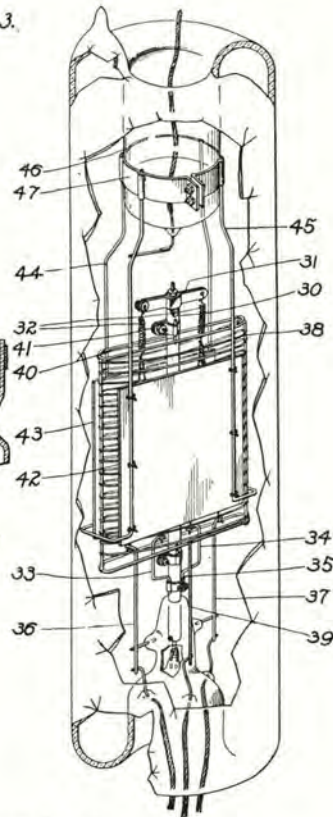

and running throughout the length of this rod of lavite is a wire which projects at its lower end at 9. This is also shown in Fig. 2, the wire 9 serving to position and hold the lower end of the lavite rod since this wire is welded to a platinum wire or wires 10, sealed into the septum 11 which seals and thereby renders airtight the top of the tubular portion 2. Intermediate its length the lavite rod 8 is supported by the contracted upper portion 12 of the tubular portion 4. Extending from the portion 13 of the wire extending from the top of the lavite rod 8 are a plurality of arms 14, which support the filamentary cathode 7 as shown. The filament cathode 7 is divided into parallel sections since alternate supporting arms 15 are electrically and mechanically connected to the band 16 clamping the tubular portion 4, the leading-in wire 17 being electrically connected to the band 16 at the points of the filaments electrically connected thereto. The remaining alternate supporting arms 18 are electrically and mechanically connected to the band 19, clamping the tubular portion 4 and electrically connecting it to the leading-in wire 20.

Beyond the portion of the wire 13 is a section 21 of lavite to which are clamped the arms 22 forming extensions of the longitudinal wires 29, upon which the grid turns are welded. The arms 22 may be clamped to the section 21 by metallic band 23.

The cylindrical anode 5 is provided with a plurality of extensions such as 24, which project through the lavite tubes 25 being clamped to the outer surface of the tubular portion 3 by the metallic band 26. The leading-in wire 27 connected to the band 26 serves as a lead for the anode. One or more of the lavite sections 25 is provided with a metallic band 28 which serves to hold and support the extension 29 of the longitudinal grid wire.

The various leading-in wires are sealed into the tubular portion 2 at widely separated points as shown to reduce leakage currents, as above described.

In the modification shown in Fig. 3, the

center post 30 is provided with a cross-arm 31 from which extend the springs 32 for supporting the two V-shaped filamentary cathode sections. The inner portions of these sections are electrically connected by the wires 33 and 34, clamped to the post 30 by the collar 35.

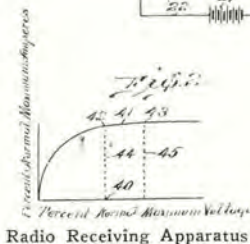
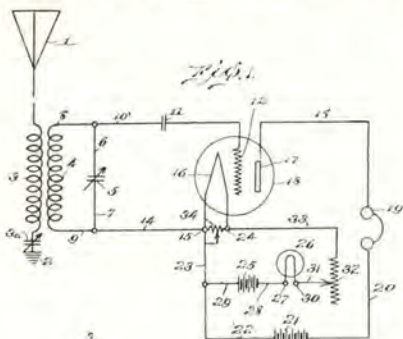

Radio Receiving Apparatus

RADIO RECEIVING APPARATUS
(Patent No. 1,473,417, issued to Frank G. Beetem, Philadelphia, Pa., under date of November 6, 1923.)

This invention relates to radio receiving systems embodying audions or vacuum tubes. One of the objects of the invention is to provide a suitable regulating device for the filament circuit of an audion or vacuum tube, so arranged with adjustable hand-operated resistances that any given setting for the filament excitation may be obtained and afterward the filament current and voltage will remain substantially constant, irrespective of normal changes in the voltage of the battery or other source supplying this filament circuit.

It is a well known fact that the voltage of primary or secondary batteries varies throughout the discharge of the battery. Starting at a given point the tendency is for the voltage to decrease more or less steadily with time during the period when current is being drawn from the battery. With some forms or types of batteries this voltage regulation is very poor and so in the case of the filament circuit of audion or vacuum tubes, compensation for the decrease of voltage of the battery exciting the filament is made from time to time with adjustable resistance in series with the filament in the battery circuit, the amount of resistance included in the filament circuit being varied by manual adjustment to maintain constant current.

In some types of radio receiving apparatus, and especially with batteries having poor voltage characteristics, the necessity for constant adjustment is exceedingly objectionable and frequently results in the loss of signals or portions thereof, which under the conditions of a constant filament current would not occur.

A particular object of this invention is to render it possible to use any type of battery, at least for a considerable period, without the necessity for constant adjustment. To accomplish this I propose to include in the filament circuit a device which will, within the limits of its particular design, automatically maintain a constant filament-current and consequently a constant filament temperature.

Further, the invention has for an object the provision of suitable means for simplifying the control of audions or vacuum tubes in the reception of oscillations of definite radio frequency by providing automatic means for maintaining constant current in the filament circuit of the audion in combination with manual means for making the initial adjustment whereby the automatic means is operated at its point of maximum effectiveness and at the same time the current in the filament is adjusted to the desired value, and is thereafter maintained at said value automatically and without further manual adjustment, notwithstanding variations in the voltage of the source of current.

Figure 1 is a diagrammatic view of the application of my invention to a form of radio receiving circuit.

Figure 2 is a diagram showing one relation

or current and voltage of an iron wire ballast. Referring to Fig. 1, the antenna 1, grounded at 2, is suitably connected to the closed, tuned circuit of the receiving apparatus as by means of the coil 3 inductively arranged with the reactance coil 4 of the closed tuned circuit. The capacity of the antenna circuit is adjusted by the variable condenser 3a. The condensance of the closed tuned circuit is provided by the variable condenser 5, connected by the leads 6, 7, with the respective leads 8, 9, of the inductance coil 4.

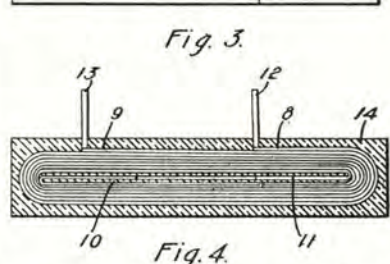
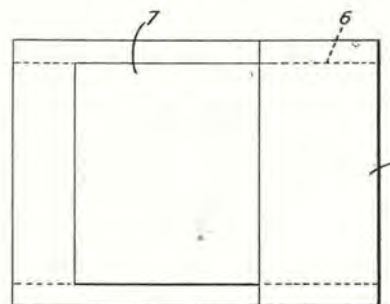
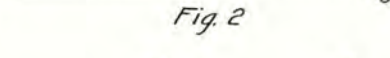
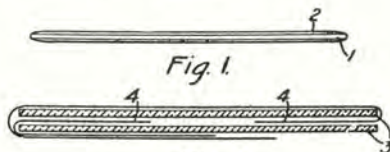

CONDENSER AND METHOD OF MAKING THE SAME

(Patent No. 1,467,776 Issued to Paul E. X. Demmler, Pittsburgh, Penna., Under Date of Sept. 11, 1923)

This invention relates to condensers and methods of making same and it has, for its primary object, the construction of condensers by a method which will insure a product of compact structure and high efficiency.

It is well known that the efficiency of a condenser is increased as the distance between the layers of conducting material embodied in the condenser is decreased. It is very desirable, therefore, that a dielectric be employed which will insure disposition of the layers of conducting material of the condenser in as close relation as possible. In view of this, one object of my invention is to provide condensers having a dielectric material which will insure compact disposition of the conducting material and, consequently, a highly efficient product.

Another object of this invention is to construct condensers by a method which will promote rapid production of such articles and thus decrease the cost of them.

A still further object is to construct condensers of readily available material which is comparatively inexpensive.

In the drawings, Fig. 1 is an end elevation of an insulated metal foil which may be employed in constructing a condenser in accordance with my invention; Fig. 2 is a diagrammatic view, illustrating a method of forming condensers in accordance with my invention; Fig. 3 is a plan view of a partially-formed condenser embodying my invention, and Fig. 4 is an end view, partly in elevation and partly in section, of a finished condenser constructed by a method hereinafter set forth.

In Fig. 1 is shown a metal foil or ribbon 1, coated with an insulating or dielectric material 2, which may be employed in constructing a condenser. Aluminium foil is especially adapted for use with the insulating material. The insulating material may be, preferably, a baking varnish, such as is em-

ployed in insulating electric conductors. The aluminium foil, when subjected to a bath of baking varnish and then drawn through a drying tower, heated to substantially 280° C., is closely united with the varnish. It is desirable to first pickle the aluminium foil in a hot hydrochloric acid bath which may comprise one part hydrochloric acid to substantially three parts of water. The aluminium foil may then be washed in water and dried. The foil may also be washed in naphtha or benzol, without any pickling. Such treatment ensures unusually good adhesion between the baking varnish and the foil.

Various materials may be employed in making a foil for use in constructing condensers in accordance with my invention.

Musical Comedy From WGY

The broadcasting of popular musical "hits" from current musical comedies by WGY, the General Electric Company studio at Schenectady, has proved quite popular among the radio "fans" recently. It is often possible to secure the entire cast of a musical production for the purpose.

"Wildflower" was the first of a number which have been broadcast recently. The complete personnel of 30 persons was brought to the studio. Among the songs which were sent "into the air" were "Wildflower" and "Bambalina."

On another occasion Raymond Hitchcock, who is touring the country in "The Old Soak," visited WGY studio and delivered one of his famous curtain speeches into the microphone. The complete cast of "Go-Go," with Bernard Granville and Texas Guinan, sang for WGY on another afternoon.

In another instance, by means of a microphone installed in an Albany theater sixteen miles away, the entire performance of "Blossom Time" was broadcast. Listeners were able to hear the parts spoken, the music and the applause of the audience in the theater.

Sturdy Battery Charger

To meet the demand of radio operators for a device for charging storage batteries of from two to four volts, to be used in connection with the Tungar Battery Charger, the General Electric Company has developed and is now placing on the market an efficient adapter.

This is a resistor of sturdy construction, the resistance wire being wound on a porcelain tube. It is designed for mounting on the inside of the top edge of the Tungar casing, which brings it beneath the cover, where it is out of the way and is protected against contact.

It is expected that there will be a great demand for this device because of the increasing popularity of the storage battery for operating the small, or so-called peanut types of tubes, the storage battery being preferred by a large number to the dry cell for this purpose.

Hundreds of Amateurs Use Code

RADIO amateurs and fans have originated, and are at the present time developing a universal language of their own. It has even been intimated that some day this or a similar elaborated language may become useful to the peoples of the whole world as an abbreviated language for the written word.

Hundreds of radio fans and amateurs are now using many of the standard radio code terms and phrases in their writings, and several are successfully using the code for making notes in their daily business.

There is nothing mysterious or remarkable in the code. It is very simple and not unlike the Phillips code, which is generally used by wire telegraphers in sending press dispatches. This radio code is based upon phonetic spelling, and in a long word many of the letters are deleted. For example, the word radiation in radio code is cut down to but three letters—rdn.

Following is a list of the most prominent, used by every dyed-in-the-wool radio amateur:

- | Code | Phrase |
|-------|------------------|
| F. B. | —fine business. |
| O. M. | —old man. |
| O. W. | —old woman. |
| hr | —hear or here. |
| hrd | —heard. |
| u | —you. |
| wen | —when. |
| ur | —your. |
| spk | —speak. |
| gud | —good. |
| hv | —have. |
| ruff | —rough. |
| pt | —point. |
| tubd | —too bad. |
| gess | —guess. |
| no | —know or no. |
| vy | —very. |
| cond | —condenser. |
| freq | —frequency. |
| thot | —thought. |
| wrk | —work. |
| wrkd | —worked. |
| hwsat | —how's that. |
| hw | —how. |
| cu | —see you. |
| cuagn | —see you again. |
| cul | —call you later. |
| 73s | —best regards. |
| B4 | —before. |
| 2nite | —tonight. |
| ltr | —letter. |

- | | |
|--------|----------------------------------|
| sorri | —sorry. |
| tt | —that. |
| gg | —going. |
| shud | —should. |
| abt | —about. |
| trub | —trouble. |
| wid | —with. |
| gnd | —ground. |
| rdn | —radiation. |
| cntpse | —counterpoise. |
| bi | —by. |
| Hi | —radio laugh. |
| mi | —my. |
| onli | —only. |
| gv | —give. |
| sum | —some. |
| diff | —difference. |
| enuff | —enough. |
| cud | —could. |
| wkg | —working. |
| inpt | —input. |
| impt | —important. |
| pri | —primary. |
| sec | —secondary. |
| wv | —wave. |
| wi | —well or will. |
| wy | —way. |
| betr | —better. |
| gvg | —giving. |
| T C A | —Thermo coupled amps. |
| C R A | —Commonwealth Radio Association. |
| cum | —come. |
| thr | —there. |
| r | —are. |
| ru | —are you. |
| cld | —called. |
| cl | —call. |
| cllg | —calling. |
| rite | —write. |
| DX | —long distance. |
| tmrrw | —tomorrow. |

- | | |
|------|----------------------|
| fr | —for. |
| crd | —card. |
| nw | —now. |
| pse | —please. |
| sed | —said. |
| aud | —audibility. |
| cr | —chemical rectifier. |
| ant | —antenna. |
| dlvr | —deliver. |
| dlvd | —delivered. |

High Power Stations Help Conference

When the first American Marine Congress met in New York City November 5 to 10 the high-power radio stations of the country took an active part in the proceedings. In appointing the WLW station as one of the important broadcasting stations to send forth the results of the big conference, Powel Crosley, Jr., was doubly honored, for he not only operates that station, but he is a member of the Associated Manufacturers of Electrical Supplies, representing seventy-eight national organizations who are participating in the American Marine Congress.

The radio committee worked upon programs for some time. Besides, Powel Crosley, Jr., there were on this committee: Herbert Hoover, Secretary of Commerce; General Pershing, United States Army; Theodore Roosevelt, Assistant Secretary of the Navy; Admiral Benson, United States Shipping Board; Rear Admiral Reynolds, United States Coast Guard; A. H. Griswold, Vice President American Telephone and Telegraph Company; Major General Harbor, President Radio Corporation of America; H. P. Davis, Vice President General Electric Company; Eugene McDonald, President Chicago Radio Laboratory, and E. B. Mallory, who is secretary of this committee.



Look at This Radio Set

Isn't it a dandy? And it performs just as well as it looks. The Ace Type V is a long range receiver and stations from coast to coast are heard distinctly. An Ace two-step amplifier in connection with this set at \$20.00 makes use of loud speaker practical. Has Crosley multistat which permits use of any make tube.

Think of the fun you'll have this winter with this set—the excellent musical entertainment. See your dealer now—if he can't supply you, order direct. Remember the low price—\$20.00. Ask for "Simplicity of Radio"—its FREE. Don't delay because every day you do without this set you are missing a world of entertainment.

ACE TYPE V

Formerly called Crosley Model V

Armstrong Regenerative Receiver

\$20.00

Licensed under Armstrong U. S. Patent No. 1,113,149

THE PRECISION EQUIPMENT COMPANY

1223 VANDALIA AVE. POWEL CROSLEY, JR., Pres. CINCINNATI, OHIO

T-100 Battery Charger

*The Best and Lowest Priced
on the Market*

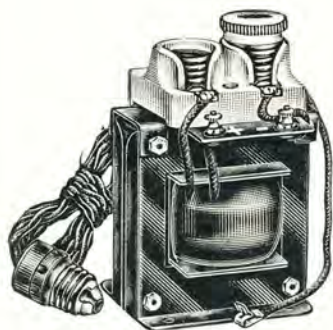

This battery charger operates on 110 volt, 60 cycle, A. C. circuit, charging a 6 volt battery at a 2 ampere rate. Standard 2 ampere charging tube is used. The T-100 is the lowest priced first-class charger on the market. Large numbers now in use have proved entirely satisfactory. No vibrating parts to get out of order. Absolutely noiseless in operation. Furnished with plug and cord for lamp socket. Battery leads marked. Fuse protects charger from accidental short circuit of 110 volt leads. Fully guaranteed.

Price complete, with 2 ampere tube, **\$12.00.**

Our New Radio Guide Book Sent at Your Request

Our new 64-page Catalog No. TCR contains twenty of the most popular radio circuits printed in blue. These include the Hazeltine Neutrodyne, Grimes Inverted, Colpitts, Flewelling, Reinartz, Diode Electrad, Heterodyne, Super-Regenerative and many others. Each article used in circuit is attractively pictured instead of appearing in straight schematic form. Besides containing blue prints, the best in radio is also illustrated and described. Catalog sent postpaid for ten cents. Each circuit worth double.

Send for your copy today

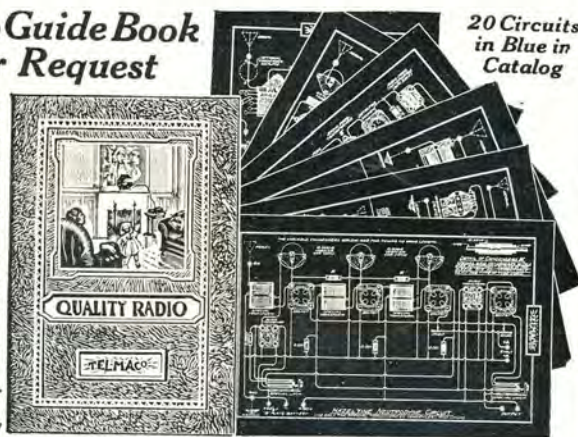

20 Circuits
in Blue in
Catalog

JOBBERS We have an attractive proposition for a few more bona-fide Jobbers

DEALERS If your Jobber cannot supply you order direct

TELMACO
Quality Radio Exclusively

Radio Division
TELEPHONE MAINTENANCE CO.

20 So. Wells St., Dept. C, Chicago, Ill.

DOES CRYSTAL SET BROADCAST?

(Continued from page 26)

368 meters, but that the clearness and volume of my broadcasting increased in clearness up to the 380 meter point, and then faded out entirely before the 500 meter adjustment had been reached.

Received Signals by Regeneration

Two facts were conclusively established by this interesting test. First, that the crystal set had been receiving music by virtue of the regeneration of my set. Second, and converse-

ly, the vibration originating in the crystal set could be heard just as plainly at my set as visa versa. That the crystal set received outside broadcast programs through the regeneration of my set was proved conclusively during a later test when Mr. B. recorded hearing several stations simultaneously with me. We verified the reception of stations broadcasting by quoting, word for word, parts of the various programs. It was found impossible to tune the crystal set to any other program while the tube set was in operation, or to get any detection whatsoever when the latter was shut down. These findings re-

sulted in making a change in the crystal set aerial, changing it from a single wire to the two wire inverted "T" type, hanging it parallel to and approximately eight feet from mine. This appeared, after careful testing, to be the most practical placement for eliminating interference in either direction.

Both sets are now working to full efficiency and for the first time Mr. B. is able to tune in on any station within a radius of his receiving power. This experience growing out of an incorrectly placed aerial proves that it is possible and quite probable that crystal sets may be made to intercept messages which are originated at a distance far beyond their normal detecting power through the agency of a regenerative set. As soon as a non-regenerative set can be gotten together still further tests will be made to arrive at a better understanding of some of the factors which will determine the relative placement for the best operation of the ever increasing number of non-parallel antennae. It will be interesting to get further data on just how this little crystal set functioned as a transmitter (if indeed it can be strictly called transmitting) with the ever present possibilities that it was merely acting as a one way valve.

So much for Mr. Graham's experience and independent investigation as a technical expert. It is hoped that he will be able to put into the films on which he will soon start work some of the same painstaking research work. Certainly it is true that there is a wonderful field untouched up to the present time and with Mr. Graham's peculiar resourcefulness, radio fans should soon find many of their problems analyzed in motion picture form at their favorite theatres. That much can be accomplished along this line is reasonable to expect, as based upon the opinion of Mr. Rehm of the Atlas Educational Film Company, who has been responsible for producing a number of highly educational films of great merit, notably an Own Your Home film entitled "The Great Idea," in which, by the way, radio plays a prominent part. Space here is too limited to go into discussion of the wonderful possibilities from a film standpoint for bringing to the public a more complete knowledge of the fundamentals of radio and the opportunities for them in its new growth. As we know the readers of RADIO TOPICS will be interested in further film developments along this line, owing to Mr. Graham's connection with the project, we will keep our readers advised from time to time.

Let's make this a radio Christmas. Considerable interest has been created by the two big radio shows in Chicago and New York, and radio week added to the success of a radio Christmas.

Why Kilocycles Instead of Meters?

THE Second Annual Radio Conference, which met with Secretary Hoover in March, introduced a method of designating radio waves which is somewhat new to the radio public. This is the use of frequency in kilocycles (abbreviated kc.) instead of wavelengths in meters.

The advantages of this practice have been familiar to radio engineers for some time, and it is probable that it will eventually replace the use of wavelength in meters. As a matter of fact, wavelength is a somewhat artificial conception in the handling of radio apparatus and is one of the difficult things for the beginner to understand. The frequency of the radio wave is the same as the frequency of the alternating current which flows in the radio transmitting or receiving set.

As often happens in technical matters, the idea of "kilocycles" is simpler than the forbidding aspect of the word suggests. "Kilo" means a thousand, and "cycle" means one complete alternation. The number of kilocycles indicates the number of thousands of times that the rapidly alternating current repeats its flow in either direction in the antenna in one second. The smaller the wave length in meters, the larger is the frequency in kilocycles.

* * *

The reason that kilocycles are coming into use and displacing meters is that the necessary separation of the frequency of transmitting stations to prevent interference is the same, no matter what the frequency may be. This necessary separation is variable and quite misleading when expressed in meters. Thus the number of radio messages that can be transmitted simultaneously without interference can be correctly judged from the kilocycles but not from the meters.

For example, the amateurs will in the future work in a band of wavelengths from 150 to 200 meters, but this is a frequency band from 2,000 to 1,500 kilocycles. This is an enormously wider band when considered from the viewpoint of kilocycles than, for exam-

ple, the band having the same width in meters from 1,000 to 1,050 meters, which is 300 to 286 kilocycles. While it is possible to carry on 50 simultaneous radio telephone communications between 150 and 200 meters, only one could be carried on between 1,000 and 1,050 meters.

In accordance with the recommendation of the Second National Radio Conference, the Department of Commerce and other government departments will hereafter follow the practice of specifying in even values of kilocycles rather than meters. The conference recommended the practice of expressing wave frequency in kilocycles per second with wavelength in meters in parentheses thereafter. The relation between the two is very simple. For approximate calculation, to obtain kilocycles divide 300,000 by the number of meters; to obtain meters, divide 300,000 by the number of kilocycles. For example, 100 meters equals approximately 3,000 kilocycles, 300 meters equals 1,000 kilocycles, 1,000 meters equals 300 kilocycles, 3,000 meters equals 100 kilocycles. For highly accurate conversion the factor 200,000 should be used instead of 300,000.—Radio Service Bulletin.



This is "J. B." of station WOR, Newark, N. J., one of the most popular broadcasting stations in the East. WOR's popular announcer is Joseph Barnett.

Novel Radio Equipped Truck

A NOVEL performance is reported from Massachusetts when the radio equipped Amrad truck returning from Nantasket Beach, where employees of the American Radio & Research Corporation, Medford Hillside, enjoying an outing, picked up Station WDAP, Drake Hotel, Chicago. The closing portion of an appeal for funds for the Japanese Relief was clearly heard



American Radio & Research Corporation truck equipped with receiver and 10-ft. aerial, with frame of truck acting as counterpoise, which picked up WDAP, WIP and other stations near Nantasket Beach, Mass.

through the loud speaker a block away. Later the Drake Hotel Orchestra rendered several selections.

The performance was remarkable because of the fact the truck has only a small antenna of about 10 feet in length installed on the roof. The reception was heard with remarkable clearness while the truck was in motion passing through Quincy. Portions of the program of Stations WIP, Philadelphia, and WGI and WNAC were also heard.

The Amrad truck is one of the few radio-equipped trucks operating daily in the country, and has attracted much attention. Through its broadcasting station, WGI, officials of the company are able to keep in touch with the truck enroute about the city and state.

Linking the Americas by Radio

THE United Fruit Company and the Tropical Radio Telegraph Company are about to establish stations at various points in Central America for the purpose of completing links of an adequate communication system between the Americas.

Six radio transmitters to be operated from vacuum tubes of the 20-kilowatt radiotron type, are being established at New Orleans; Miami, Fla.; Puerto Barrios, Guatemala; Tegucigalpa, Honduras; Managua, Nicaragua; and Almirante, Panama.

The United Fruit Company established the first radio stations in Central America and was the first to establish commercial radio communications between Central America and the United States. It was shortly after the International Yacht races off Sandy Hook had been reported by radio that the first radio sending and receiving sets were purchased and installed at Port Limon, Costa Rica, and Bocas del Toro, Panama. This was in 1904 and service was inaugurated the following day.

The operation of these two stations convinced the directors of the United Fruit Company that radio was practical and valuable in a business which handled such a highly perishable product as the banana. So the year following, or 1906, stations were opened at Bluefields and Rama, Nicaragua. All these stations, because of the lack of land communications, handled in addition to the company's business a large share of the telegraph business of the general public between these places and the United States and Europe.

Other stations have followed since then until now, with the six new tube transmitter stations, there will be a total of nineteen, comprising what is known as the United Fruit Company's radio system. All stations of the United Fruit Company's system, including all their ships of the "Great White Fleet" are to be equipped with tube transmitters of a similar type.

The United Fruit Company has spent more than \$3,000,000 in the development of its radio and upon the completion of new stations under construction its investment in radio will probably exceed \$4,000,000.

Since 1911 the radio activities of the company in all its branches have been under the immediate direction of George S. Davis, who is general manager of their Radio Telegraph department. He is also president and a director of the Wireless Specialty Apparatus Company, general manager of the Tropical Radio Telegraph Company and a director of the Radio Corporation of America.

In the operation of these transmitters, in some cases where stations are located in remote places, the primary power is generated at the station by gas or oil engine driven alternators supplying 220 volts. In other stations the power is obtained from the distribution system of the local power company. This power first goes to the service panel where complete apparatus for control, protection and metering is installed. Then it goes to the rectifier which consists of a bank of transformers and six, twelve and one-half kilowatt kenetrons. Here the voltage is stepped up and rectified, to become 15,000 volts direct current. This high voltage is then used for plate power on the pliotron oscillators.

The frequency is controlled by means of a master oscillator employing one, one kilowatt pliotron. The master oscillator provides a lower power radio frequency supply which is then amplified to twenty kilowatts of power by means of one of the new water cooled twenty kilowatt tubes. The amplified power is passed through a tank circuit which eliminates harmonics and then fed into the multiple tuned antenna.

Keying is accomplished by means of a relay on the master oscillator unit. This relay may be controlled from any desired distance and is adapted to keying speeds of sixty words per minute.

New Non-Inductive Potentiometers

RADIO fans who are using wire wound potentiometers and have had trouble with inductance in their receiving circuits will be interested in this new non-inductive potentiometer recently perfected by the Central Radio Laboratories, Milwaukee, Wisconsin.

The new instrument has a thin resistance element made of pure graphite and is not only non-inductive but also free from "skin



effect." This feature of the design eliminates the choke coil effect found in wire wound potentiometers and also insures the same resistance to radio frequency as to direct current.

Smooth noiseless operation is made possible by the unique CRL pressure contact which consists of a circular disc of brass placed between the resistor and the pressure shoe and mounted in such a way that it can be made to engage the resistor at any one of an infinite number of points. As the resistor is not touched by the sliding shoe there can be no wear. The moulded base is provided with a transparent cover which protects the parts from dust and moisture and allows a clear view of the interior.

The CRL Non-Inductive Potentiometer (No. 110) has a resistance of 400 ohms which is the best value for accurate adjustment of plate potential and grid bias in vacuum tubes. A 2000 ohm type (No. 111) is also made for special applications.

Sharpen Your Tuning

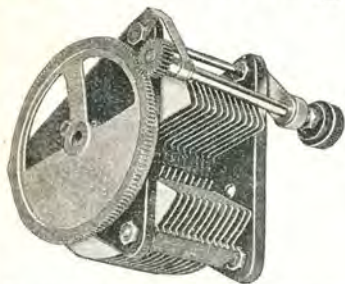

No operator of a radio receiving set need be told of the advantage of sharp precise tuning. It is not always clear, however, how this may be obtained. After a good tuning coil has been chosen look to the CONDENSER for the answer.

Here are some of the important features: Sharp tuning through low loss design, using hard rubber properly placed—heavy brass plates soldered together keeping capacity constant and greatly reducing danger of short-circuiting—low zero capacity giving wide wavelength range—a CONTINUOUS VERNIER formed by a gear and pinion combination. Only one setting required.

Made in three sizes, 250, 500 and 1000 m.m.f. to fit every circuit. Mounted condensers are fitted with calibrated direct reading capacity dial.

Prices \$3.00 to \$8.50. Send for Educational Pamphlet "Quality Condensers" and new RADIO BULLETIN 91-T.

General Radio Company

Manufacturers of Electrical and Radio Laboratory Apparatus
Massachusetts Ave. and Windsor St.
CAMBRIDGE MASSACHUSETTS



Rainbow Multi-Plug and (8 ft.) Cable

Either panel or binding post mounting. Does away with unsightly wires. Leaves set free from live wires when not in use.

Several binding post ends can be connected to different sets—using one plug and cable connected to batteries, etc.

Ideal for dealers—and experimenters. Prices Multi-Plug and Cable Panel Mounting type \$4.00. Binding Post type complete \$5.00 Write for illustrated folder of Howard B. Jones Radio Products.

HOWARD B. JONES
612 S. CANAL ST. CHICAGO, ILL.

New Radio Receiver for the Ladies

A BEAUTIFUL piece of furniture containing a remarkably efficient and selective three tube receiver with built-in loud speaker is now found in the Ace 3C Console set made by the Precision Equipment Company, Cincinnati.

This type of receiver appeals

particularly to the ladies on account of its being completely self-contained. Unsightly wires, batteries and other accessories are hidden from view. For range and volume it is all that can be desired, it is said. It is so simple that a child can tune it and bring in distant stations clear and loud.

A stand is provided if desired, making a complete self-contained radio receiver of the floor type. The stand is designed to match perfectly the Console set.

This is a three tube Armstrong regenerative receiver, containing the new VARIND basket weave variable inductance. This unit is wonderfully selective and the Crosley Type "D" Condenser, which is part of the equipment, permits remarkably sharp tuning, enabling one to pick up distant stations through local broadcasting. This set operates more efficiently on an out-of-door antenna, although excellent results can be obtained from a comparatively short antenna under average conditions. A single wire run along the ceiling or floor for a distance of from thirty to forty feet, will, under most conditions, serve as a very satisfactory antenna for long distance reception.

The size of the cabinet is 13 3/4 inches deep. It is made of solid mahogany, beautifully rubbed, piano finish.

The set is provided with a phone jack to plug in head phones for tuning, using two tubes. When the plug is removed the three tubes are automatically connected to the loud speaker.

Improved New Charger Just Out

The Valley Electric Company of St. Louis is now in full production on the new Valley Type ABC battery charger, the improved model which the company has put out this year.

The Type ABC charger has been designed so that it is the only charger which is needed for all radio batteries. It is built on the same principle as the other successful Valley Rectifiers, but it is made for use on all types of radio storage batteries.

The new Valley charger will charge 2-volt peanut tube batteries, 6-volt A batteries, and one, two, three and four 24-volt B Batteries. It has a tap for 12-volt batteries and may consequently be used on the radio fan's 6

Your pilot over the RADIO WAVES

Whatever the radio course you have set for yourself, here is your one best guide.



JUST OUT
—
562 PAGES

Compiled by HARRY F. DART, B.S.E.E. Formerly with the Western Electric Co., and U. S. Army Instructor of Radio.

Technically Edited by F. H. DOANE

THIS is what you want in a radio book. It answers your every question as it occurs to you. Look up the thorough index, turn to the page, and there you are! The most complicated facts about radio and electricity explained as easily as the most simple ones.

Everything included. Compiled by an expert formerly of the Western Electric Co., the organization that knows most about radio in the world, and edited by another famous engineer. Understood by thousands of laymen because written especially for them. Yet—and here is the real marvel of this book—the advanced amateur, constructor and experimenter also find in it the data they need for calculating the constants of transmitters, receivers and associated apparatus for all radio purposes.

SOME OF THE FEATURES: Electrical terms and circuits, antennas, battery construction and maintenance, generators and motors, vacuum tubes (really explained), every receiving hook-up, radio and audio frequency amplification, broadcast and commercial receivers, super-regeneration, codes, license rules, etc.

Send \$1 to-day and get this 562-page I. C. S. Radio Handbook—the biggest dollar's worth in Radio. Money back if not satisfied.

TEAR OUT HERE

INTERNATIONAL CORRESPONDENCE SCHOOLS
Box 8292, Scranton, Penna.

I enclose One Dollar. Please send me—post-paid—the 562-page I. C. S. Radio Handbook. It is understood that if I am not entirely satisfied I may return this book within five days and you will refund my money.

Name.....

Address.....

or 12-volt automobile battery. It can also be used on C radio storage batteries.

In order to make this new and complete radio battery charger harmonize with the home radio receiving set, the Valley Company has adopted a bakelite panel for the face of the charger with fittings and other parts in keeping with the use to which the instrument is to be put. The new charger is being sold at no advance in price over other models.

Solid Comfort

comes with the use of the

TRADE MARK
AUDIOPHONE

REG. U. S. PAT. OFFICE

because nothing is lost from the original broadcasting.

Not only is it easily possible to distinguish the words of the speaker, but also the minute graduations in pitch, timbre and quality of overtones which distinguish individual voices.

The Audiophone is complete and self-contained—needs no separate battery or other accessories—goes to you ready for use on connecting to your receiving set. It will prove a source of lasting pride and pleasure.

Sr. Audiophone, price.....\$32.50
Jr. Audiophone, price.....22.50
Baby Audiophone, price.....12.50



Bristol One-Stage Power Amplifier

If greater volume is desired, over what you already obtain, use the Bristol One-Stage Power Amplifier. No C Battery required. Price\$25.00

Write for Bulletin and address of the nearest dealer handling our instruments.

The Bristol Company
WATERBURY, CONN.

THE BRISTOL COMPANY
Waterbury, Conn.

Please send me without cost or obligation to myself Bulletins Nos. 3006 and 3011-P on Bristol Audiophone and One Stage Power Amplifier.

Name

Street and No.....

City and State.....

makers, so to speak, found an utterly impossible proposition brought to light.

The real reason why radio tubes can now be successfully repaired is because the internal elements (the grid, plate and supports) can be put through a process that returns them to the same chemically pure metals they were before they were made into the original tube they composed. This work requires very careful handling under the cleanest conditions possible, one speck of dirt from the atmosphere being sufficient to destroy the usefulness of the finished product.

* * *

When tubes are received for repairs, and after they have been carefully recorded and tabulated, they are put through the initial operation, which is that of removing the base. The bases are accumulated and sent through their process, which is cleaning out, reaming out the contact post holes, then dipping the base in acid to remove all marks, as well as dirt, and lastly, it is polished and set aside to await its tube when finished.

In the meantime the tube, which remains intact after removal from the base, is started on its long journey. The outside glass is cracked off; the plate, grid and stem through which the lead wires run, are then separated, cleaned, and put through a special process mentioned in a preceding paragraph. Following this the parts reach the assembly bench, where girls wearing gloves made for the purpose start the very careful assemblage of the elements around the new filament wire, which has been welded to the supports on the stem.

The next move is to the glass blowers, where the new glass bulb, which has been tabulated, is sealed onto the stem; a test is there made for leaks in the seal, and if none appear the tube then goes to the exhausting station, where it goes through a long drawn-out process of expulsion of all air from the tube. To do this properly it is necessary to heat the tube from the inside as well as from the outside while the filament is burning at maximum. Only the most carefully constructed station, comprised of much special equipment, can properly do this work. The least slip at this juncture means all the previous labor is lost and the spoiled tube has to go through all the preliminary operations again.

* * *

Before basing the now sealed up tubes they are put through a close test to determine point of oscillation, consumption of current, degree of vacuum, etc. In addition to this they are carefully tested again for leaks, and if perfect they go to the basing operation, which also must be done carefully, and they must pass another test, the same as the previous one, in order to be certain they are based properly and that nothing has happened to them since the first test. After this they are tested for performance in an actual set, and if passed they go on their journey back to their original owners.

The Fine Art of Repairing Burnt Vacuum Tubes

REPAIRS to radio vacuum tubes has long been one of the most discussed subjects among radio fans. Unfortunately for some of the fraternity the repairing of radio tubes remained in an experimental stage until some months ago. It was not entirely the fault of the pioneers in this particular business that its

present success was not brought about in the beginning.

Back in the early days of 1922, and many times since, the demand for tubes has far exceeded the supply; this naturally induced the thought that if new tubes could be made the old ones could be repaired. On the surface it certainly looked as if it was an easy job to replace the burned out filament, repump the air out of the new bulb, and the tube would be as good as it ever was. It is admitted that a few adventurous individuals apparently thought that it was no harder to refill a radio tube than to half-sole a pair of shoes. These shoe-

Reliable
RADIO
Goods

Distributors for:
Radio Corporation
of America

Grebe	Western Coil
Atwater Kent	Magnavox
Brandes	Burgess
Murdock	Gould
Nath. Baldwin	Eveready
Western Electric	Frost
Acme	Carter
All American	Dubilier
Signal	Howard
Chelsea	Eby
Cutler-Hammer	Bradley
	Jewell

and, other standard
manufacturers

We carry a comprehensive stock of the latest receiving sets, parts and supplies of the leading manufacturers and ship from stock promptly.

Free Catalog Illustrated,
sent on request.

Dealers: Buy reliable equipment from a house of established reputation. Send for catalog of tested and approved apparatus and our discount sheet.

Julius Andrae & Sons Co.
114 Michigan St. Milwaukee, Wis.

ANDRAE In Business Since 1860

READABLE HOOK-UP PRINTS

"Proven by Test to Be the Best"

1. Hazeltine Neutrodyne with two steps of R. F. amplification.
2. Cockaday Four Circuit tuner, showing how to add 1 or 2 steps of A. F. amplification. Great selectivity.
3. Armstrong Super Heterodyne using only 7 dry battery tubes. Has but 2 controls. A Rolls Royce set.
4. Improved Ultra Reinartz with 2 stages of A. F. amplification. The best Reinartz.
5. Grimes' Inverse Monotrol Reflex with 3 tubes, reflexed inversely on 2. The best reflex.

Each blue print is informative, naming manufactured parts to buy, giving exact assembly directions, and telling how to wind special coils where fan likes to make everything possible. Price, 50 cents each, or all five for \$1.75. Send money orders only to

HOME WORKSHOP CO.,
P. O. Box 1062D, Chicago, Ill.

Operate a Loud Speaker on One Tube

We have a new wonder circuit that will efficiently work your loud speaker on a single tube on local stations. Over 2,000 miles have been covered loud and clear with phones. Parts are few and inexpensive. Easy to build. Send 25c for hook-up and complete instructions.

LEUMAS RADIO LABORATORIES
311 Fifth Avenue New York

RADIO FOR WHOLE FAMILY

(Continued from page 22)

only satisfied with the finest of instruments. It was originally built as the private receiver of one of the managers, but after his friends had heard it, they also wanted one like it. One after another, these special orders came pouring in until the Petit Grand automatically took its place as the finest that Perasco could produce. This instrument will receive over a radius of 3,000 miles over a loud speaker very consistently. Interference of the local stations has no bar to its receiving. Los Angeles, Calif., comes in loud enough to fill the home or the private dance hall, and with the complete elimination of the local stations. The local stations (within a radius of 75 miles) are received with such volume that conversation in the ordinary room is impossible. Because of its volume, do not think that tone values have been sacrificed. All who have heard it in operation have remarked as to its unusual combination of tone quality with that of volume. The finest five tube receiver that has yet been produced.

The Perry Radio Supply Company is fully awake to the progress of radio science in the reception of telephone signals. As the newer circuits are developed and tested, the best will only be found in their instruments. Each type is different in its make-up, and not just the placing of one standard type in cases of different design. Each type has one particular service to fill and must be the best of its type before it is allowed to bear the Perasco name. This means that the purchaser of any Perasco instrument is obtaining one which is typical of the highest development of modern efficiency.

Let's make this a radio Christmas. Considerable interest has been created by the two big radio shows in Chicago and New York, and radio week added to the success of a radio Christmas.



Three Aces!
BURGESS
RADIO BATTERIES

IN the experience of radio engineers, amateurs and experimenters there is a suggestion which clearly points the way to the battery buyer who desires the most fitting and practical combination of electrical energy, low cost per hour of service, long shelf life and uniformity of discharge.

"ASK ANY RADIO ENGINEER"
More than a mere phrase these words express the preference of radio engineers who have learned the limitations of ordinary batteries and who have found in Burgess products the built-in efficiency which Burgess has achieved to an unequalled degree.

These "Three Aces," the famous Burgess "B"—the new *double strength* Radio "A," and our latest product, the Vertical "B" Battery are playing an important part in correct and dependable reception of radio broadcast. Each is

"A Laboratory Product"

Good dealers everywhere recommend and sell Burgess Batteries

BURGESS BATTERY COMPANY

Engineers—DRY BATTERIES—Manufacturers
Flashlight—Radio—Ignition—Telephone

General Sales Office:
Harris Trust Building, Chicago
Laboratories and Works: Madison, Wisconsin

Branches:
New York Boston Washington St. Paul
Kansas City New Orleans

In Canada:
General Offices and Works: Niagara Falls, Ontario
Branches: Toronto, Montreal, Winnipeg, St. John



GAMBLING?

YOU ARE IF YOUR RADIO TUBES ARE UNPROTECTED



Your Vacuum Tubes are the most delicate parts of your Radio Set.

They are easily blown out—you have probably already had this exasperating experience—it is apt to happen at any time.

"B" Battery wires accidentally crossed for only an instant with the filament leads or sudden excess current from the "A" Battery will do it.

You can prevent this and save yourself money and inconvenience and relieve your mind at a trifling cost.

INSTALL RADECO SAFETY FUSES

on all your tubes. Applied in an instant to one of the filament terminals. Will fit any standard tube going in any standard socket.

Price 50 cents each, sent postpaid and fully guaranteed. Do not delay. Order now. Specify type of tube used.

DEPT. 4

Radio Equipment Company

Manufacturers and Distributors of Standard Radio Equipment

630 WASHINGTON STREET

BOSTON, MASS.

New England's Oldest Exclusive Radio House

Dealers:—Write for our proposition

New Powerful Army Radio Station

The Army Signal Corps is busy installing a radio station at Fort Douglas, near Salt Lake City, Utah, which will be the largest radio telegraph station of the army. It will have but one tube, that the new 10 kilowatt radiotron developed by the General Electric Company, which is building the equipment.

Another similar station is being erected at Leavenworth, Kan., but this station will operate with two tubes and will have a telephone circuit as well as the radio telegraph. The radio circuit between these two stations, the Arlington, Va., station and a land line from Leavenworth to San Francisco, will span the United States. Each of the two interior stations will be equipped with two steel 300-foot towers.

It is the plan of the army radio service not to use coastal stations, that part of the work being handled by the Naval Communication Service, and the army does not desire to interfere with ship to shore communication.

THE CURE-ALL

WE had a man in our town
famed
As one who never smiled.
With disposition dour and
gray,
Disliked by man and child.

Till one day sudden changes came,
He seemed quite blithe and gay.
This metamorphosis, 'tis said,
Explained itself this way.

His wife, a dame of modern bent,
Acquired a radio snappy,
Then straightaway taught her better half
The one way to be happy.

He fell for it, like fish for bait,
Grand opera, song and tale,
While wifely smiled, full well she
knew,
That this way couldn't fail.

Where frowns held forth, there's
only smiles,
Old Gloom has seen the light.
With head phones on, he seems to
dwell
On some celestial height.

For cheerless folk of doleful mien,
The remedy is plain;
Let wireless drive dull care away,
And pure contentment reign.

W. B. SHENESSY.

Loud Speaker \$1

Radio Adapter
Hear all broadcasting through phonograph. Make your own horn. Attach B-R Phonadapter to YOUR phonograph. All can hear. Entire family, neighbors, guests can hear operas, lectures, latest news, with this adapter. Stretches over receiver of any standard type head-set and attaches to tone-arm of ANY phonograph. Made of soft, pure gum rubber. Quickly attached and removed. Thousands in use. Will not amplify or distort. For single receiver **.50**
For pair of receivers (more than twice the volume) \$1

Go to your dealer. If he cannot supply you send money order, check or currency at our risk. Prompt delivery—postpaid. Also send us name of favorite radio dealer.

The Beckley Ralston Company
1811 So. Michigan Ave., Chicago, Ill.

Radio Tubes Repaired

We will repair your old tubes for you at following prices:

W-11, WD-12	\$3.25
C-11, C-12	3.25
UV-200, C-300	2.75
UV-201, C-301	3.00
UV-201-A, C-301-A	3.25
UV-199, C-299	3.25

Tubes guaranteed same as new.
Tubes returned same day C. O. D.

DEY'S RADIO SERVICE

Dept. F, 235 Pine Ave., Chicago, Ill.

Public Sales

We Have Purchased

122,000 Pair

U. S. ARMY MUNSON LAST SHOES

Sizes 5½ to 12, which was the entire surplus stock of one of the largest U. S. Government shoe contractors.

This shoe is guaranteed one hundred per cent solid leather, color dark tan, bellows tongue, dirt and waterproof. The actual value of this shoe is \$6.00. Owing to this tremendous buy we can offer same to the public at \$2.95.

Send correct size. Pay postman on delivery or send money order. If shoes are not as represented we will cheerfully refund your money promptly upon request.

**National Bay State
Shoe Company**

296 Broadway, New York, N. Y.

The TOWN CRIER of TODAY



IN the quaint old villages and towns of long ago, when each community was a world unto itself, the Town Crier played an important part in the affairs of the day. With clanging bell and stentorian voice, he broadcast the news, perhaps weeks old, that occasionally drifted in from outside places.

Today news from all parts is immediately available right at your fireside. No matter how isolated your abode, Radio binds you to civilization. By a turn of the dial, the happenings, entertainments and amusements of the world are yours to command.

The Crosley Manufacturing Co. has done much towards bringing this new wonder within the reach of all and has made Radio a living, tangible thing—something to use in daily life, in business or pleasure.

Popularly priced, these famous receivers give perfect performance. Unsolicited letters are received daily from owners telling of satisfaction and new distance records.

Every day tests prove to us that Crosley instruments are the most simple and efficient Radio receivers ever offered to the public, regardless of cost.

*For Sale By Good Dealers
Everywhere.*

Write for complete catalog. This fully describes the Crosley line of Radio parts and receivers, which range in price from a 2-tube set at \$28 to a beautiful Console Model at \$150.



CROSLEY

Better - Cost Less
Radio Products

The Broadcasting Station WLV is maintained by the Crosley Manufacturing Co.

CROSLEY MANUFACTURING CO.

POWEL CROSLEY, Jr., President
1223 Alfred St., Cincinnati, O.

CROSLEY

Model X-J
\$65



Crosley Model X-J \$65

A 4-tube radio frequency set combining one stage of Tuned Radio Frequency Amplification, a Detector and two stages of Audio Frequency Amplification. A jack to plug in on three tubes for headphones, the four tubes being otherwise connected to loud speaker, new Crosley Multistat, universal rheostats for all makes of tubes for dry cells or storage batteries, new condenser with molded plates, filament switch and other refinements add to its performance and beauty.

Nowhere can a better receiver be purchased at any price.

Cost of necessary accessories from **\$40.00** up. List prices on our equipment west of the Rockies 10% higher. In Canada, add duty.

MAIL THIS COUPON TODAY.

Crosley Manufacturing Co.,
1223 Alfred St., Cincinnati, O.

Gentlemen: Please mail me free of charge your complete catalog of Crosley instruments and parts together with booklet entitled "The Simplicity of Radio."

Name
Address

Radio Catalogue Free

Write us a post card—

and we will send you free this 52 page catalogue of radio sets and parts. It also contains explanation of radio terms, map and list of broadcasting stations and much radio information, including an explanation of successful hook-ups and circuits.

You will be amazed at the low prices Ward's quote. A complete set for \$32.50 equalling sets at \$60 elsewhere—a \$23.50 set that under favorable conditions has a radius of 500 miles and more.

This catalogue contains everything for the expert and amateur. Complete sets and every improved part for building sets, all the most up-to-date devices—at the lowest possible prices.

Headquarters for Radio

Montgomery Ward & Co. is headquarters for Radio, selling everything direct by mail without the usual "Radio-profits." Why pay higher prices? Ward quality is the best and the prices will often save you one-third. Everything sold under our Fifty Year Old Guarantee,—Your Money Back if You Are Not Satisfied. Write today for your copy of this complete 52-page Radio Book.

Write to the house nearest you. Address Dept. 3-R
Chicago Kansas City St. Paul Portland, Ore. Fort Worth

Montgomery Ward & Co.

— The Oldest Mail Order House is Today the Most Progressive —



"STONE DEAF" HEAR RADIO MUSIC

At the New York institution for instruction of deaf and dumb it was recently demonstrated that by the application of amplified electrical vibratory sound currents, persons regarded as "stone deaf" were able to hear radio music.

The experiments were conducted by David Grimes, radio expert and electrical engineer. A receiver with no aerial, ground wire or outside connection was employed by Mr. Grimes in the experiments.

Radio Has a "Ford"

Somebody recently dubbed Powell Crosley, Jr., president of the Crosley Manufacturing Company, the "Henry Ford of Radio," and it seems as though the title would stick. Mr. Crosley is one of the pioneers of builders of low priced radio apparatus and his factory at Cincinnati, O., has reached a production point of 1,000 complete receivers a day. The Crosley booth at the recent Chicago Radio Show, was one of the most popular spots on the floor of the Coliseum.

As to Radio Frequency

A regenerative set is equal to a non-regenerative set using one stage of radio frequency. Do not try to employ radio frequency with regeneration unless you are technically inclined. Radio frequency will amplify a weak signal so that the detector tube will rectify it, but as a rule a regenerative set will accomplish practically the same results. Radio frequency is employed to amplify weak signals while audio frequency is employed for giving volume.

Do you ever applaud the artists you hear over the radio? By applauding we mean do you take the time to drop that particular station, or artist, a line telling them how you enjoyed a particular piece? At the theater you applaud. Why don't you applaud the radio artists? They're human and will appreciate it quite as much as the actors upon the speaking stage. Drop them a post card or letter when pleased. It's one way to improve programs and encourage talent.

\$3 DOWN Brings you a Genuine **UNDERWOOD** TYPEWRITER

10 DAYS FREE TRIAL Your \$3.00 unconditionally returned if at end of 10 days you are not satisfied with this late model UNDERWOOD typewriter rebuilt by the famous Shipman Ward process.

GREAT PRICE SAVING Direct to you from the largest typewriter factory of its kind in the world by our money saving methods.

EASY MONTHLY PAYMENTS So small that you will not notice it while you enjoy the use of this wonderful machine.

FREE BOOK OF FACTS Explaining Shipman Ward's wonderful system of rebuilding typewriters and also valuable information about the typewriter industry both instructive and entertaining.

Act Today! Mail Coupon **5 Year Guarantee**

Shipman Ward Mfg. Company
3079 Shipman Building
Montrose & Ravenswood Aves., Chicago

Please send me a copy of your free book of facts, explaining bargain offer.

Name.....
St. and No.....
City..... State.....

We Repair The Following Radio Tubes

And Guarantee Them

WD-11 ... \$3.50	UV-199 ... \$3.50
WD-12 ... 3.50	C-259 ... 3.50
UV-200 ... 2.75	UV-201A ... 3.50
UV-201 ... 3.00	C-301A ... 3.50
C-300 ... 2.75	UV-202 ... 4.00
C-301 ... 3.00	C-302 ... 4.00
DV-6 ... 3.00	DV-6A ... 3.50

Mail Orders solicited and promptly attended to

Dealers and Agents, write for Special Discount

H. & H. RADIO CO.
P. O. BOX 22-R
Clinton Hill Sta. Newark, N. J.

FROSTONES Best for Your Radio Set

Bring in programs clear and sweet; free from distortion. Highest quality—biggest value. 2000 ohms, \$5; 5000 ohms, \$6.

HERBERT H. FROST, Inc.
154 W. Lake St. • Chicago

A MICROMETER RHEOSTAT

The standardized Rheostat, furnished in three resistances, to fit all tubes: 6½, 25, 40, and 60 ohm Rheostats

As implied by the name, this Rheostat is provided with a POSITIVE and EXTREMELY SENSITIVE CONTROL.

By its use "gas tubes" may be operated at the peak of the receiving efficiency.

The desired control is obtained by turning the SINGLE KNOB through less than ONE complete turn.

THINK OF IT! ANY FRACTION of the resistance contained in a wire EIGHTY INCHES LONG may be inserted in the circuit by operating the SINGLE KNOB through LESS THAN A COMPLETE TURN.

Also, duplicate settings can be made at any time, without difficulty.

SPECIFICATIONS

Resistance—zero to approximately seven ohms.
Current carrying capacity 1½ amperes.
Temperature co-efficient practically zero.
Base and knob—special heat resisting composition.

PRICE \$1.50

Price including special dial described below, \$1.75

MICROMETER ATTACHMENT. The micrometer attachment described in connection with the above rheostat has been so designed that it can be placed on any regular Howard rheostat in about one minute's time. Price for attachment only 50 cents.

HOWARD MICROMETER RHEOSTAT



Micrometer Rheostat, Exclusive License under C. R. L. U. S. Patent No. 1,461,634



Patent No. 870,042



We manufacture a special dial for use with micrometer rheostat and attachments described above. PRICE 25 CENTS.

The Howard Multi-Terminal Plug, the Quick Change Plug, makes instant connections for any number of receivers from one to six pairs.

Sold with the Guarantee of Satisfactory Performance. Price \$2.00.

HOWARD RADIO COMPANY

Discounts to the Electrical and Jobbing Trade

4248 NORTH WESTERN AVE., CHICAGO, ILL., U. S. A.

PATENTS

To the Man with an Idea

I offer a comprehensive, experienced, efficient service for his prompt, legal protection and the development of his proposition.

Send sketch of model and description, for advice as to cost, search through prior United States patents, etc. Preliminary advice gladly furnished without charge.

My experience and familiarity with various arts frequently enable me to accurately advise clients as to probable patentability before they go to any expense.

Booklet of valuable information and form for properly disclosing your idea free on request. Write today.

RICHARD B. OWEN, Patent Lawyer
81 Owen Bldg., Washington, D. C.
2278-M Woolworth Bldg., N. Y. City

WLW Gives Theater Reviews

In order to give the radio audience as wide a range in informative service as possible, the WLW radio broadcasting station of the Crosley Manufacturing Company, Cincinnati, devotes a portion of its Monday schedule for theatrical and movie reviews. The movie reviews are given every Monday at 4 o'clock and the theatrical reviews at 9:30 p. m. Members of the studio staff see the movies and the dramatic and musical attractions and then give a review to the unseen radio audience.

Radio for Christmas

DON'T overlook that growing boy. If he's normal he'll be interested in radio.

And he'll get more solid enjoyment out of a crystal set or a one tube receiver than all the mechanical trains or flying machines ever invented.

Let's make this a Radio Christmas.

PRICES REDUCED

Send card today asking for our complete list of knocked down outfits and radio parts at reduced prices. Our book "Radio Construction for the Amateur" will prove a big help to you. Price only fifty cents. A sample saving follows. You may order any part or parts you desire.

Complete Regenerative Vacuum Tube Receiver.		Approximate Range 1,000 Miles.	
	Our	Price	Others
Panel 7"x12" already drilled.....	\$1.75	\$1.75	\$2.50
Cabinet k. d. of 3-ply wood to fit... 1.50	1.50	2.30	
2 three-inch dials @ .30c each.....	.60	1.00	
16 switch points with nut @ .01c.....	.16	.48	
4 switch stops with nut @ .01c.....	.04	.12	
8 binding posts, nickel plated @ .03c	.24	.48	
2 switch levers with 1½" radius @			
25050	.80	
1 filament rheostat, Good grade.....	.50	1.00	
1 180° vario-coupler, 16 taps.....	2.75	3.50	
1 23-plate variable condenser.....	1.75	2.80	
1 tube socket of high quality.....	.45	.75	
1 phone and 1 grid condenser @ 15c	.30	.50	
1 set transfers for marking panel....	.20	.30	
9 feet spaghetti tubing @ .04c.....	.36	.54	
1 tube socket support.....	.20	.30	
20 feet soft copper connecting wire... 20	.20	.30	
1 copy "Radio Construction for the Amateur"50	.50	
	\$11.95	\$18.32	

Some other articles from our list are:
Frost head set, 2,000 ohms..... \$ 3.45 \$ 4.00
Transformer-Audio frequency
"Rhamstine"..... 3.00 4.00
Detector tube, 6-volt, "Independ
ent"..... 2.95 4.00
Two step amplifier parts complete.. 13.95 21.50

WHAT THEY SAY:

A great many unsolicited testimonials with reference to the above k. d. outfit have been received. A couple are:

Roxbury, Connecticut.
Am getting excellent service from my one tube single circuit receiver, which was bought knocked down from you. Have heard ninety-four stations, including PWX at Havana, Cuba, and my friends think it is great.
JOHN S. ROBINSON.

Covington, Tennessee.
The set which we made from your parts is giving good satisfaction. We have heard 1,500 miles or more air line. Have heard KIZ, KWH, KHX, the last two being in Los Angeles, California.
C. H. OWEN.

Radio Parts Manufacturing Company

1247 Marlborough Dept "T" Detroit, Michigan

SEND NO MONEY



A limited quantity of Standard Make, high grade, fully guaranteed typewriters at lowest price ever offered.

FREE TRIAL

for five days in your own home. Easy monthly payments. No "red tape". Send Today for Free Booklet of Valuable Typewriter Information, also Special Sale Bulletin.

Smith Typewriter Sales Co.
-360 E. Grand Ave., Chicago, Ill.

Railroad Fare



Student Winding a Stator

To the Great Shops of **Coyne**

We pay your railroad fare to Chicago—the Electrical Center of the World—from any place in the United States. Grasp the opportunity to see the country at our expense. Come to Coyne—learn electricity in 3½ months. Get a complete training so you can make big money as Power Plant Operator, Superintendent, Telephone man, Construction worker, auto, truck or tractor electrician, battery man, radio expert, or you can go into business for yourself as electrical contractor, dealer, auto ignition or battery expert and make from \$3,000 to \$20,000 a year. Hundreds of our graduates today are making big money and you can do the same if you grasp this opportunity—act now.

Learn Electricity In 3½ Months

No books or useless theory. You are trained on \$100,000 worth of electrical equipment. Everything from door bells to power plants. You work on motors, generators, house-wiring, autos, batteries, radio, switch-boards, power plants—everything to make you an expert ready to step right into a position paying from \$45 to \$100 a week.

Radio Course FREE

We include the following free with the regular course:
(1) A complete course in auto, truck and tractor electricity and storage batteries. Greatest outlay of auto, electrical and battery equipment in the country.
(2) Course in Radio—the marvel of the age. Constructing, installing and operating. You can build your own wireless telephone set.
(3) A life scholarship in the Coyne school. You can stay as long as you wish and return for further training at any time in the future.

Earn While You Learn

We help students to secure jobs to earn a good part of their expense while studying.

Send Coupon Now

Don't delay a minute—send that coupon in **right now** for our big free catalog and full particulars of Free Railroad Fare offer. Act now!

B. W. COOKE, President

Coyne Trade and Engineering School
Dept. 5993 1300-1310 W. Harrison St., CHICAGO

B. W. Cooke, Pres. Coyne Trade and Engineering School,
Dept. 5993 1300-1310 W. Harrison St., Chicago, Ill.

Dear Sir: Please send me free your big catalog and full particulars of your special offer of Free Railroad Fare and two extra courses.

Name

Address

ANNOUNCEMENT

THE GREAT NORTHERN STEAMSHIP COMPANY

(Incorporated)

BOSTON, MASS.

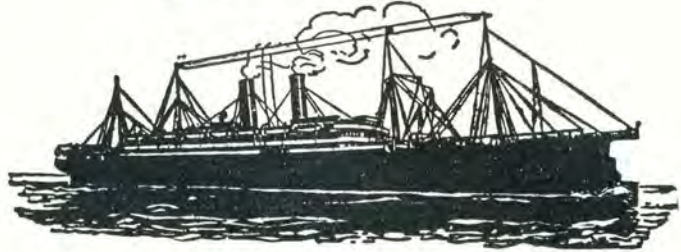

Announces that arrangements are now being made for monthly

\$110 Round Trips to Europe

Boston—Southampton

\$110

ONE WAY \$65

Connecting for

London, Liverpool, LeHavre

Boston—Gothenburg

\$138

ONE WAY \$75

Connecting for

Christiana, Stockholm, Helsingfors,
Danzig, Riga, Copenhagen

THE ABOVE PRICES INCLUDE RAILROAD FARES TO POINTS AS FAR NORTH AS STOCKHOLM

The Company plans to carry approximately two thousand passengers monthly. Make your plans now for a trip during the coming season.

Lives of passengers will be protected by

EVER-WARM SAFETY-SUITS

which prevent drowning and protect from exposure

A round trip, with all expenses on ship-board included, at no more expense than a vacation right here at home! To meet the ever increasing demand in this country for an inexpensive and at the same time thoroughly comfortable and enjoyable trans-Atlantic voyage, is the prime object of the Great Northern Steamship Company. Organized by progressive business men who realize the exceptional opportunity offered now for inexpensive travel in Europe, the Company will cater to the thousands of

intelligent persons who wish to visit the battlefields of France, the Shakespeare country, Scandinavia, the Land of the Midnight Sun, etc. A chance of a lifetime! So it would seem; but it is more than that. The Company is building for permanent business, setting a new standard of high-class ocean travel on a one-class basis. That this can be done at a fair margin of profit has already been proved and is further outlined in our prospectus. You'll find it extremely interesting.

WE WILL ALSO SHOW YOU HOW YOU MAY BECOME A PART OWNER IN THE MOST TALKED-OF ENTERPRISE IN YEARS

✂ Cut out and mail us with your name and address ✂

A. Wikstrom
Information Dep't
Edmunds Bldg., Suite 54
Boston, Mass.

I am interested in securing full information regarding a trip to:
(Mark with a cross) One way Round trip
England _____
France _____
Germany _____
Sweden _____
Norway _____
Denmark _____
Baltic Provinces _____
Finland _____
Russia _____

Name _____
Street or R.f.d. _____
City or Town _____
State _____

A. Wikstrom
Information Dep't
Edmunds Bldg., Suite 54
Boston, Mass.

I am interested in becoming part owner in the Great Northern Steamship Company.

Please send me proposition and full particulars.

Name _____
Street or R.f.d. _____
City or Town _____
State _____



ZENITH

Licensed under
Armstrong
U. S. Patent
No. 1,113,149

AT THE NORTH POLE

THE AMERICAN RADIO RELAY LEAGUE
HARTFORD, CONN.

RADIOGRAM

Radio Station: _____
From: _____
To: _____
Date: _____
Via: _____

IF AN EIGHT TUBES SET IS USED CHECKER NUMBERED RADIO ADJUSTED WITH IT IS RECOMMENDED THAT THE SET BE USED IN THE MIDDLE OF THE BAND FOR ALL THE UNITED STATES



Model 4R—The new Zenith 4R "Long-Distance" Receiver-Amplifier comprises a complete three-circuit regenerative receiver of the feed-back type. It employs the Zenith regenerative circuit in combination with an *audion detector* and *three-stage* audio-frequency amplifier, all in one cabinet. Because of the unique Zenith "selector," unusual selectivity is accomplished without complication of adjustment.

The Zenith 4R may be connected directly to any loud-speaker *without* the use of other amplification for full phonograph volume, and reception may be satisfactorily accomplished over distances of more than 2,000 miles **\$85**



Model 3R—The new Zenith 3R "Long-Distance" Receiver-Amplifier combines a specially designed distortionless three-stage amplifier with the super-efficient Zenith three-circuit regenerative tuner.

Fine vernier adjustments—in connection with the unique Zenith aperiodic or non-resonant "selector" primary circuit—make possible extreme selectivity.

2,000 to 3,000 Miles with Any Loud-Speaker

The new Zenith 3R has broken all records, even those set by its famous predecessors of the Zenith line. Satisfactory reception over distances of 2,000 to 3,000 miles, and over, is readily accomplished in full volume, using *any ordinary loud-speaker*. No special skill is required.

The Zenith is the only set built which is capable of being used with all present-day tubes as well as with any tubes that may be brought out in the future. The Model 3R is compact, graceful in line, and built in a highly finished mahogany cabinet **\$160**

ZENITH RADIO CORPORATION, Dept. A
328 South Michigan Avenue, Chicago, Illinois

Gentlemen:—
Please send me illustrated literature on Zenith Radio.

Name

Address

Inside the Arctic Circle, nine degrees from the North Pole, a little 89-foot schooner is frozen fast in the ice of Smith Sound. Aboard this schooner a group of brave men are enduring, as best they can, the desperate cold of the Arctic—cold that often drops to 60 degrees below zero. Human atoms in a boundless field of ice!

Cold is hard to endure, but far more terrible is the Arctic solitude—unbelievably oppressive. Radio, at length, has broken this spell forever!

Concerts from Honolulu!

Daily, by means of powerful sending and receiving apparatus, the crew of the "Bowdoin" are in communication with relatives and friends in the far-off States. Daily they listen to concerts as far away as Chicago, Dallas, and Honolulu!

When the sanity, the very lives of one's shipmates may depend upon contact with the outside world, none but the *best* is good enough.

Dr. MacMillan's Choice—the Zenith

Out of all the radio sets on the market, Dr. MacMillan selected the Zenith exclusively—because of its flawless construction, its unusual selectivity, its dependability and its tremendous *reach*.

Already his operator, on board the "Bowdoin" in Northern Greenland, has tuned in several hundred stations. You along the Atlantic who brag a little when you tune in Catalina Island—what would you say if you tuned in Hawaii *from the Arctic Circle?*

The set that Dr. MacMillan has is a standard Zenith receiving set. And you can do all that MacMillan does, and more, with either of the two new models shown at the right. Their moderate price brings them easily within your reach. Write today for full particulars.

Zenith
Radio Corporation
McCormick Building
CHICAGO

"THE BETTER RADIO" PIERASCO

INSTRUMENTS THAT EXCEL

WHY not brighten the year, yea, the entire life of the friend this Xmas, by sending the world's best in song, music, literature and news to his fireside through the gift of one of our Renown Radio Receivers?

\$50.00



\$50.00

TYPE PR-II RECEIVER

The refined friend who entertains with its sweet, true tones free from blast. Upkeep low and inexpensive. Only.....**\$50.00**



KEWPIE

Always brings cheer, inspiration, gratefulness and thankfulness to that sick shut-in mother, father or child. Only**\$25.00**

TYPE PA-III AMPLIFIER

Combined with Kewpie makes the family fireside entertainer. Together will operate a loud speaker. Only**\$35.00**



THE PETIT GRAND

An especially designed instrument with exquisite tone and volume for company entertainment or private dances. Only**\$175.00**

Perry Radio Supply Company

218 Washington Boulevard
River Forest, Illinois

Get a Job Like These Earn \$3500 to \$10,000 a Year



20 Years Old— Makes Almost \$500 a Month

Harold Hastings of Somers, Mass., says: "The profit on my electrical business amounts to \$475.00 a month. My success is due entirely to your instruction. You make your men just what you say—Electrical Experts. No man will ever make a mistake enrolling for your course."



Dickerson Gets \$7500 a Year

"I earned \$30 a week when I started with you—\$50 a week when half through your course. Now I clean up at the rate of \$7500 a year. Thank you a thousand times for what you did for me. Electricity pays big on the farm." Herbert M. Dickerson, Warrentown, Va.



\$20.00 a Day for Schreck

"Use my name as a reference and depend on me as a booster. The biggest thing I ever did was answer your advertisement. I am averaging better than \$500 a month from my own business now. I used to make \$18.00 a week." A. Schreck, Phoenix, Ariz.



Pence Earns \$9000 a Year

W. E. Pence, Chehalis, Wash., says: "Your course put me where I am today, Mr. Cooke—making \$750 a month doing automobile electrical work—think of it—\$9000 a year. Besides that I am, my own boss. My wife joins me in thanking you for what you did for us."



\$30 to \$50 a Day for J. R. Morgan

"When I started on your course I was a carpenter's helper, earning around \$5.00 a day. Now I make from \$30 to \$50 a day and am busy all the time. Use this letter if you want to—I stand behind it." J. R. Morgan, Delaware, Ohio.



Spare Time Work Pays Stewart \$100 a Month

"Your course has already obtained a substantial increase in pay for me and made it possible for me to make at least \$100 a month in spare time work. You can shout this at the weak fellows who haven't made up their minds to do something yet." Earl Stewart, Corona, Calif.

in the Big Pay Field of **ELECTRICITY**

It's your own fault if you don't earn more. Blame yourself if you stick to your small pay job when I have made it so easy for you to earn \$3500 to \$10,000 a year as an electrical expert. Electrical Experts are badly needed. Thousands of men must be trained at once. One billion dollars a year is being spent for electrical expansion and everything is ready but the men. Will you answer the call of this big pay field? Will you get ready now for the big job I will help you get? The biggest money of your life is waiting for you.

I Will Train You at Home

I will train you just like I trained the six men whose pictures you see here. Just like I have trained thousands of other men—ordinary, everyday sort of fellows—pulling them out of the depths of starvation wages into jobs that pay \$12.00 to \$30.00 a day. Electricity offers you more opportunities—bigger opportunities—than any other line and with my easily learned, spare time course, I can fit you for one of the biggest jobs in a few short months' time.

Quick and Easy to Learn

Don't let any doubt about your being able to do what these other men have done rob you of your just success. Pence and Morgan and these other fellows didn't have a thing on you when they started. You can easily duplicate their success. Age, lack of experience or lack of education makes no difference. Start just as you are and I will guarantee the result with a signed money back guarantee bond. If you are not 100% satisfied with my course it won't cost you a cent.

Free—Electrical Working Outfit and Tools

In addition to giving my students free employment service and free consultation service, I give them also a complete working outfit. This includes tools, measuring instruments, material and a real electric motor—the finest beginners' outfit ever gotten together. You do practical work right from the start. After the first few lessons it enables you to make extra money every week doing odd electrical jobs in your spare time. Some students make as high as \$25 to \$35 a week in spare time work while learning. This outfit is all FREE.

Mail Coupon for FREE BOOK— The Vital Facts of the Electrical Industry

The coupon below will bring you my big free electrical book—over 100 interesting pictures. The real dope about your opportunities in electricity—positive proof that you, too, can earn \$3500 to \$10,000 a year. Send for it now. Along with the book I will send you a sample lesson, a check allowing you a \$45.50 reduction, my guarantee bond and particulars of the most wonderful pay-raising course in the world. Send the coupon now—this very second may be the turning point in your life. Send it while the desire for a better job and more money is upon you, to

L. L. COOKE, Chief Engineer

Chicago Engineering Works

DEPT. 97-A 2150 Lawrence Ave., Chicago

The Cooke
Trained Man
is the Big
Pay Man



L. L. COOKE, Chief Engineer
Chicago Engineering Works, Dept. 97-A
2150 Lawrence Ave., Chicago, Ill.
Without obligating me in any way send me the "Vital Facts," your Free Book. Sample Lessons and particulars of your Free Outfit Offer, Free Employment Service, and proof that you can fit me for a big-pay electrical job.
Name _____
Address _____

WorkRite Former

\$2.00



This aircore Transformer has been perfected for use in the Neutrodyne method of receiving. It should be used with .0004 mfd. variable condenser for tuning to all broadcasting wavelengths. It can also be used as a transformer for tuned radio frequency reception, or fixed coupler with condenser secondary. It is made with tubes of moulded Bakelite and wound with green silk wire. Extreme care has been taken to see that the tubes are properly spaced and just the right number of turns of wire are used, insuring maximum efficiency. Like all WorkRite products, it has been thoroughly tested by other laboratories as well as our own before being put on the market. It will measure up to the "WorkRite" standard of quality and efficiency.

Watch for the WorkRite Variable Condenser

WorkRite Super Vernier Rheostat

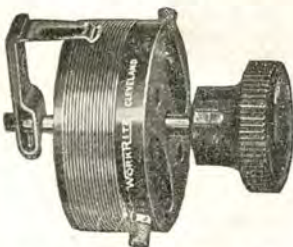

This improved WorkRite Vernier Rheostat is just the instrument you have been looking for, 50,000 possible adjustments. A turn of 1-32" will separate two stations or clear up one. Made in three different resistances so that there is a WorkRite Vernier Rheostat for every tube now on the market. 6 ohms, \$1.00; 15 ohms, \$1.15; 30 ohms.....\$1.25

WorkRite E-Z-Tune Dial Snappiest Dial on the market. Has a knurled flange on the rim for delicate leverage. Price75c

WorkRite Resistance Cartridge

Raises the resistance of your 5 or 6 ohm Rheostat to the 15 or 30 ohms required for UV 199, and similar tubes. Price, either 15 or 25 ohms.....40c

WorkRite Neutralizing Condenser

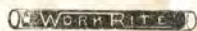

Neat, compact and very efficient. This instrument has a glass insulation on the outside which greatly expedites neutralizing the set. Price each, 25c.

WorkRite Tuner Team

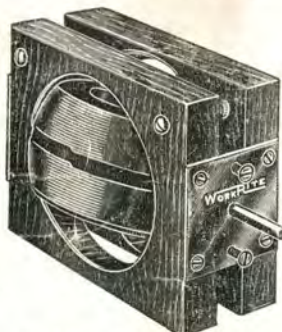

WorkRite Super Variometer

Tunes out local stations and gets the one you want. This famous Tuner Team is made up of two WorkRite Super Variometers and one WorkRite 180° Super Variocoupler. Variometer is made from polished mahogany. Variocoupler made from moulded Bakelite and wound with green silk wire. Range 150 to 705 meters. Shaft 3-16".

WorkRite Super Variometer, each.....\$3.50

WorkRite 180° Super Variocoupler, each.....\$3.50



WorkRite 180° Super Variocoupler

WorkRite Nonmicrophonic Socket



Here is the right Socket for use with your UV 199 and C 299 Tubes. It is moulded with a sponge rubber base in one piece which is even better than the soft rubber recommended for use with these tubes. Very neat and attractive. Price60c

WorkRite Hydrometer

You need one for your storage "A" battery. Full instructions with each instrument. Price75c

WorkRite Head Set

Very Sensitive. Light and sanitary. Try one and see. Price\$6.00

WorkRite Switch Set

Just what you want. Use the block for drilling panel. Arms and points made to work together. Price50c

**"WORKRITE RADIO PARTS
WORKRITE"**

THE WORKRITE MANUFACTURING CO.

5536 EUCLID AVENUE

(BRANCH OFFICE, 536 LAKE SHORE DRIVE, CHICAGO)

CLEVELAND, OHIO

Say you saw it in "Radio Topics" when writing to advertisers.